

Эффективность света:

133 Lumen/Watt

Качество света:

CRI: 85,8

Цветовая температура:

4017 K

Поток: 6502 lm

Интенс.: 2310 cd

Мощн.: 48,9 W

КПД: 0,96

4 PLANES



Название продукта:

VILED CC

M1-U-H-48-266.100.173-4-0-67

Дата и время:

22.11.2017 15:39:51

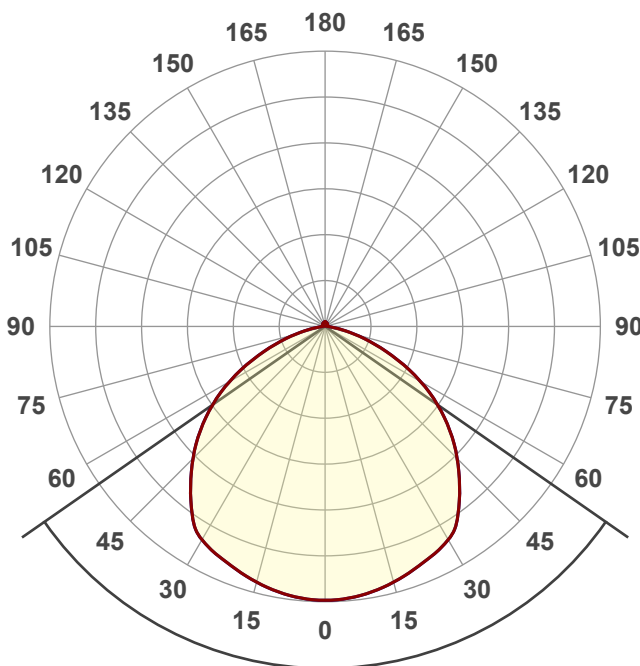

Угол пучка

110,3°

Цвет



CIE1931

x: 0,361

y: 0,351

Спектр

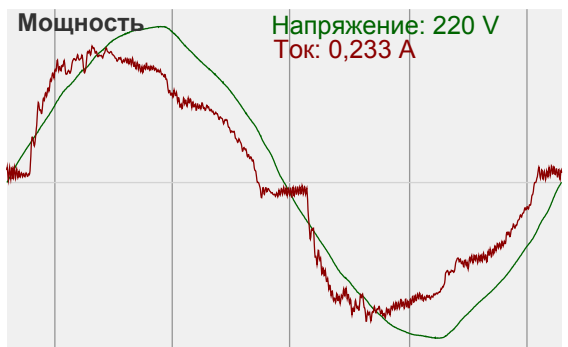
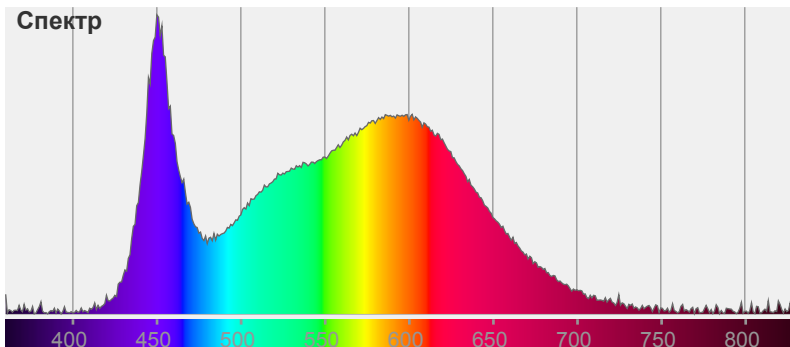

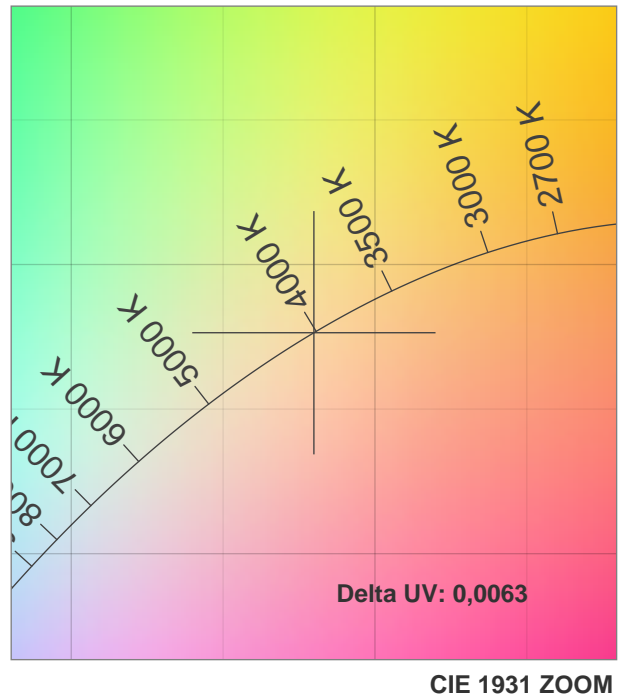
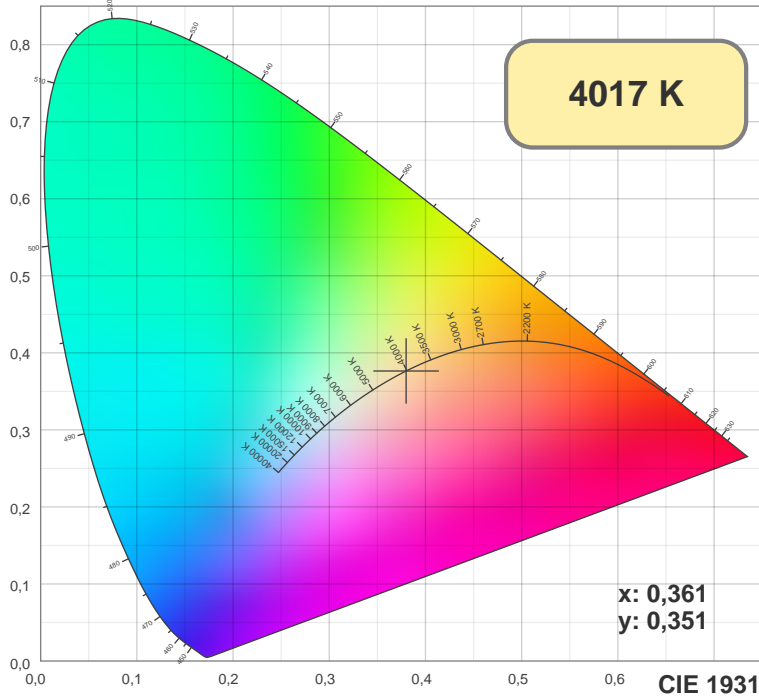

TM30: 82,4

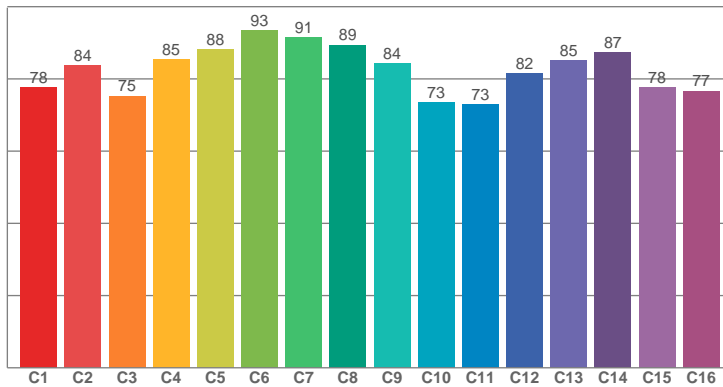

CRI: 85,8 (R1-R8)

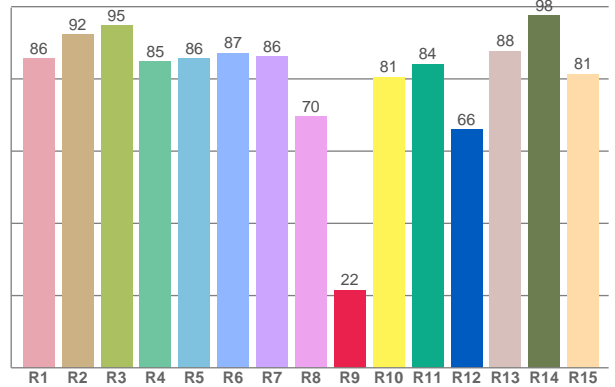

CRI R values, only R1-R8 are used to calculate final CRI value

R1	R2	R3	R4	R5	R6	R7	R8	R9	R10	R11	R12	R13	R14	R15
85,65	92,34	94,72	84,79	85,66	87,18	86,15	69,52	21,60	80,53	84,12	65,95	87,78	97,54	81,34

TM30 C values, 16 binned values out of total of 99 C values

C1	C2	C3	C4	C5	C6	C7	C8	C9	C10	C11	C12	C13	C14	C15	C16
77,56	83,80	75,26	85,47	88,13	93,49	91,40	89,43	84,28	73,42	73,00	81,54	85,09	87,32	77,65	76,66

CQS Q values

Q1	Q2	Q3	Q4	Q5	Q6	Q7	Q8	Q9	Q10	Q11	Q12	Q13	Q14	Q15
84,09	98,52	76,17	72,85	80,34	84,46	87,05	89,61	97,01	86,77	82,13	80,41	81,04	74,27	77,81

CQS: 82,0

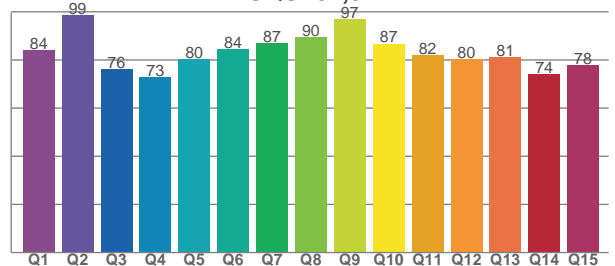

Color parameters

CCT	CRI	CRI R9	TM30 Rf	TM30 Rg	CQS	x	y	u	v	Duv
4017 K	85,8	21,6	82,4	97,0	82,0	0,4	0,4	0,2	0,3	0,0063

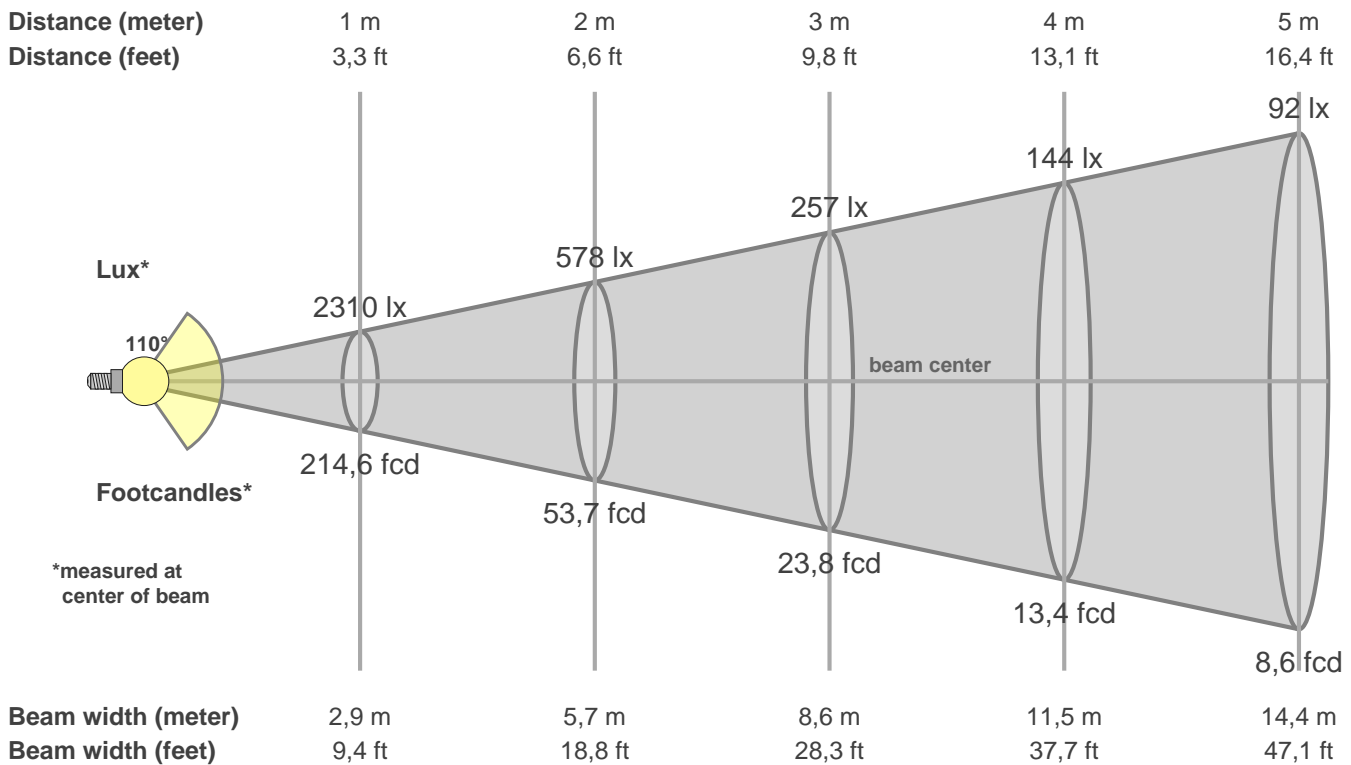

Intensities in 0° c-plane

0°	5°	10°	15°	20°	25°	30°	35°	40°	45°	50°	55°	60°	65°	70°	75°	80°	85°	90°	95°
2310	2301	2274	2234	2186	2135	2072	1948	1767	1576	1377	1162	931	689	462	271	129	49	24	22
100%	100%	98%	97%	95%	92%	90%	84%	76%	68%	60%	50%	40%	30%	20%	12%	6%	2%	1%	1%

Intensities in 90° c-plane

0°	5°	10°	15°	20°	25°	30°	35°	40°	45°	50°	55°	60°	65°	70°	75°	80°	85°	90°	95°
2310	2301	2274	2234	2186	2135	2072	1948	1767	1576	1377	1162	931	689	462	271	129	49	24	22
100%	100%	98%	97%	95%	92%	90%	84%	76%	68%	60%	50%	40%	30%	20%	12%	6%	2%	1%	1%

Intensities in 180° c-plane

0°	5°	10°	15°	20°	25°	30°	35°	40°	45°	50°	55°	60°	65°	70°	75°	80°	85°	90°	95°
2310	2301	2274	2234	2186	2135	2072	1948	1767	1576	1377	1162	931	689	462	271	129	49	24	22
100%	100%	98%	97%	95%	92%	90%	84%	76%	68%	60%	50%	40%	30%	20%	12%	6%	2%	1%	1%

Intensities in 270° c-plane

0°	5°	10°	15°	20°	25°	30°	35°	40°	45°	50°	55°	60°	65°	70°	75°	80°	85°	90°	95°
2310	2301	2274	2234	2186	2135	2072	1948	1767	1576	1377	1162	931	689	462	271	129	49	24	22
100%	100%	98%	97%	95%	92%	90%	84%	76%	68%	60%	50%	40%	30%	20%	12%	6%	2%	1%	1%

Beam angle 50%	Field angle 10%	Cutoff angle 2,5%	Intensity ratio in 120° cone	Intensity ratio in 90° cone
110,3°	152,4°	167,9°	81,7%	56,6%