

Эффективность света:

**131 Lumen/Watt**

Качество света:

**CRI: 85,5**

Цветовая температура:

**4081 K**

**Поток: 4174 lm**

**Интенс.: 1497 cd**

**Мощн.: 31,8 W**

**КПД: 0,92**

4 PLANES



Название продукта:

**VILED CC**

**M1-U-H-32-266.100.173-4-0-67**

Дата и время:

**22.11.2017 15:01:27**

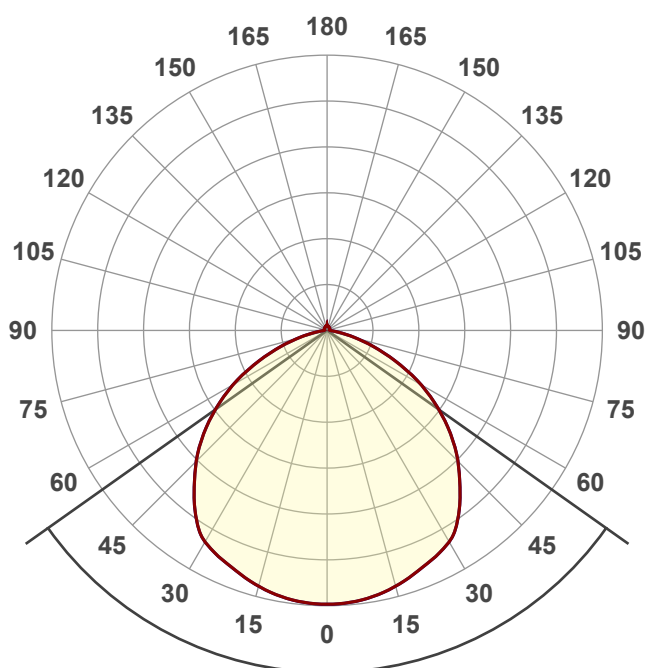

Угол пучка

**109,4°**

Цвет



CIE1931

x: 0,362

y: 0,354

Спектр

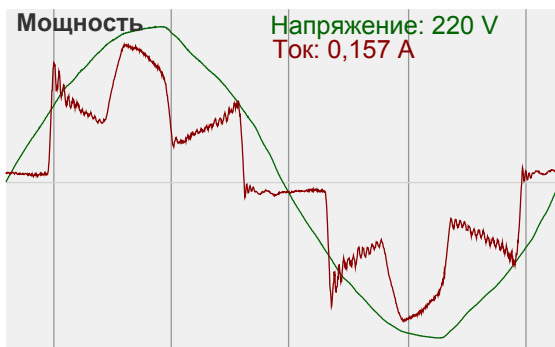
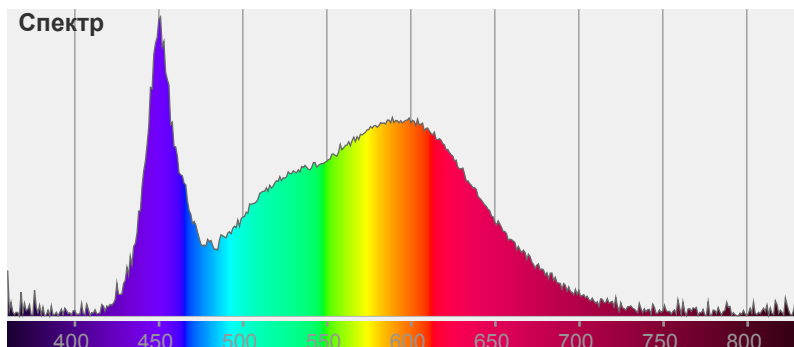

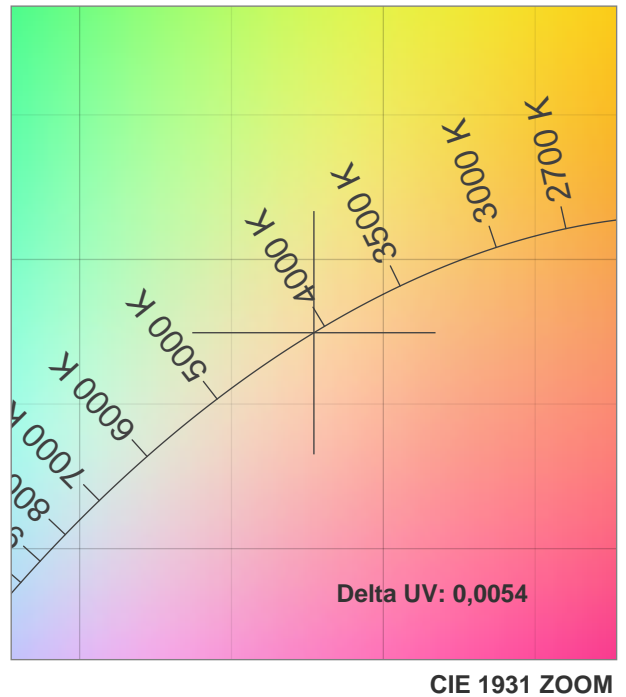
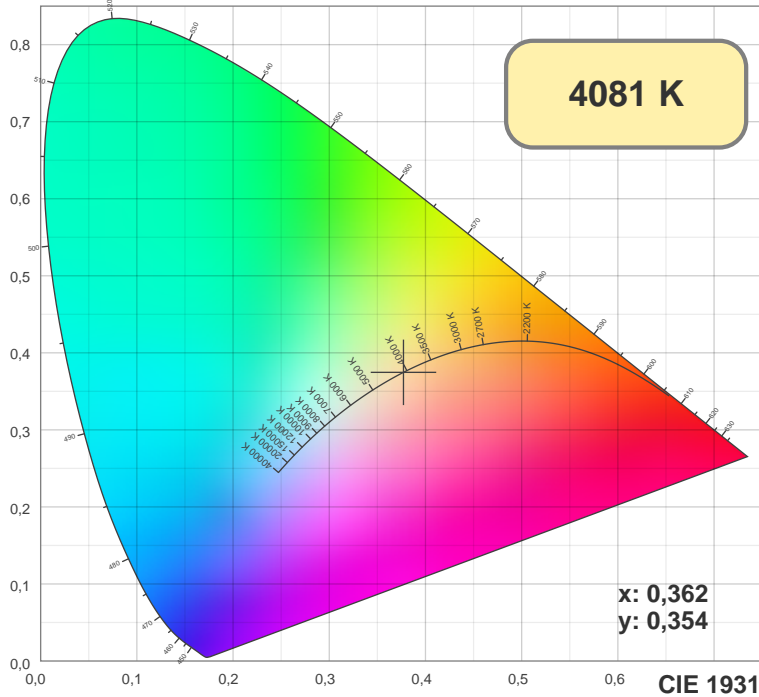

TM30: 82,4

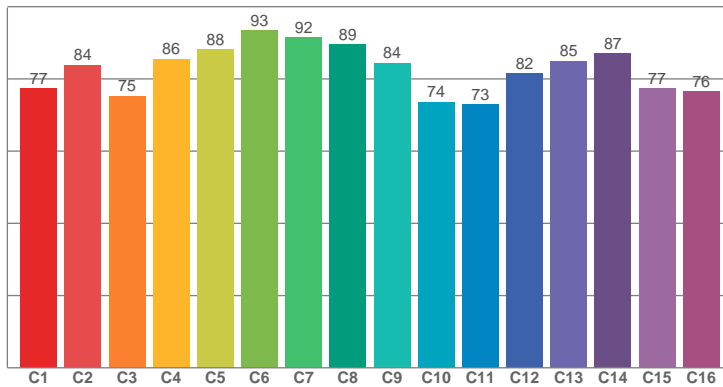

CRI: 85,5 (R1-R8)

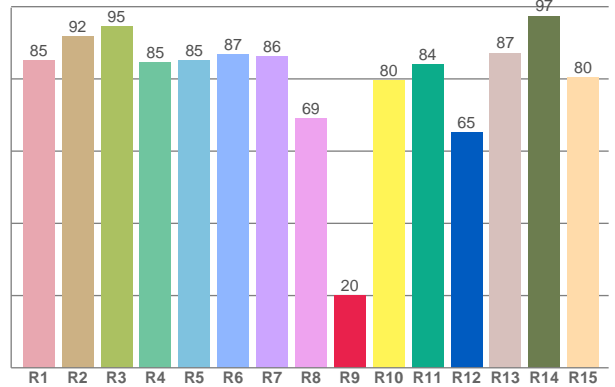

CRI R values, only R1-R8 are used to calculate final CRI value

R1	R2	R3	R4	R5	R6	R7	R8	R9	R10	R11	R12	R13	R14	R15
85,16	91,85	94,63	84,66	85,18	86,85	86,27	69,09	19,99	79,50	84,06	65,19	87,22	97,41	80,49

TM30 C values, 16 binned values out of total of 99 C values

C1	C2	C3	C4	C5	C6	C7	C8	C9	C10	C11	C12	C13	C14	C15	C16
77,40	83,88	75,25	85,53	88,10	93,44	91,51	89,49	84,46	73,61	73,03	81,52	85,01	87,05	77,37	76,45

CQS Q values

Q1	Q2	Q3	Q4	Q5	Q6	Q7	Q8	Q9	Q10	Q11	Q12	Q13	Q14	Q15
83,80	98,54	76,36	73,29	80,62	84,48	86,88	89,54	97,10	86,91	82,53	80,93	81,45	73,98	77,52

CQS: 82,1

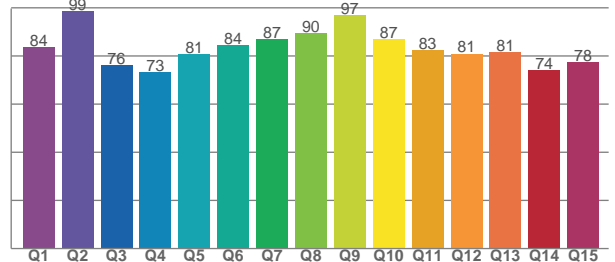

Color parameters

CCT	CRI	CRI R9	TM30 Rf	TM30 Rg	CQS	x	y	u	v	Duv
4081 K	85,5	20,0	82,4	96,9	82,1	0,4	0,4	0,2	0,3	0,0054

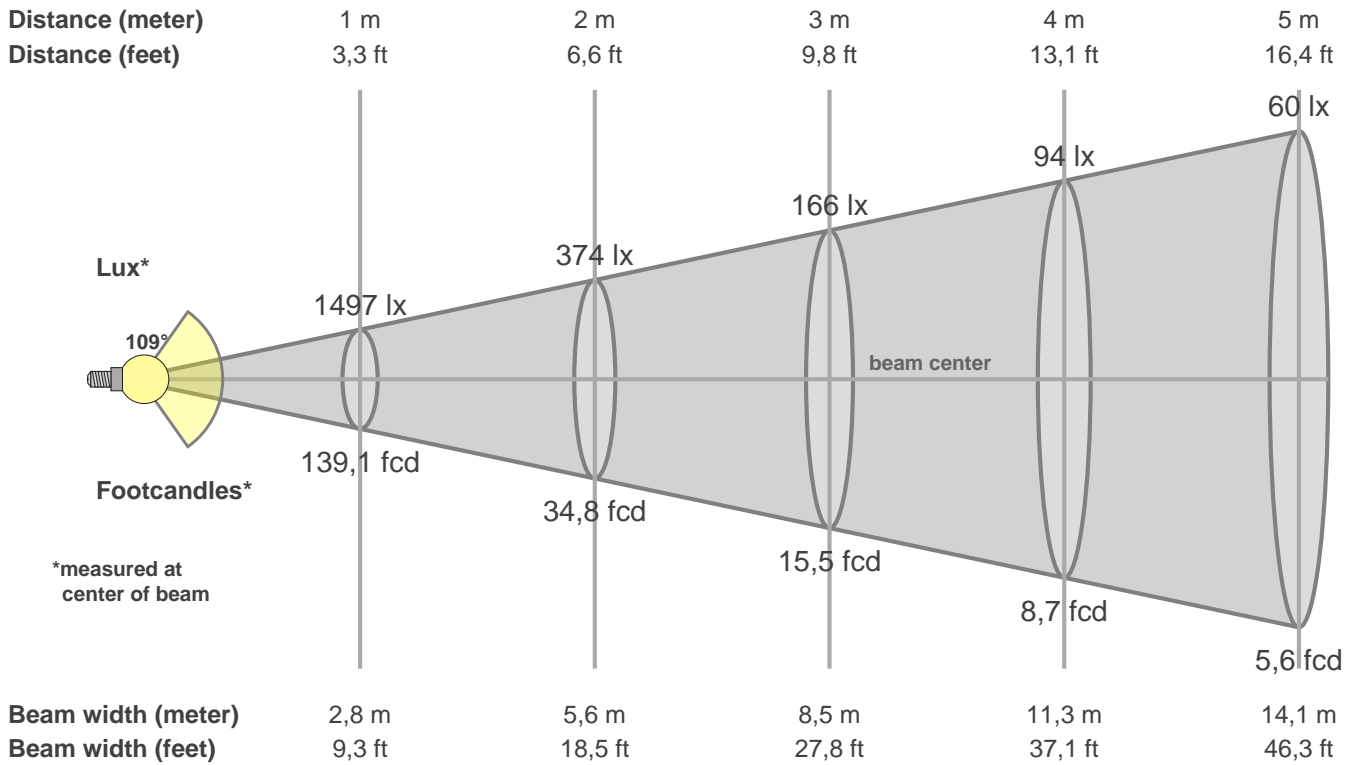

**Intensities in 0° c-plane**

0°	5°	10°	15°	20°	25°	30°	35°	40°	45°	50°	55°	60°	65°	70°	75°	80°	85°	90°	95°
1497	1492	1476	1448	1412	1376	1332	1247	1131	1012	881	740	593	437	292	169	80	30	16	15
100%	100%	99%	97%	94%	92%	89%	83%	76%	68%	59%	49%	40%	29%	20%	11%	5%	2%	1%	1%

**Intensities in 90° c-plane**

0°	5°	10°	15°	20°	25°	30°	35°	40°	45°	50°	55°	60°	65°	70°	75°	80°	85°	90°	95°
1497	1492	1476	1448	1412	1376	1332	1247	1131	1012	881	740	593	437	292	169	80	30	16	15
100%	100%	99%	97%	94%	92%	89%	83%	76%	68%	59%	49%	40%	29%	20%	11%	5%	2%	1%	1%

**Intensities in 180° c-plane**

0°	5°	10°	15°	20°	25°	30°	35°	40°	45°	50°	55°	60°	65°	70°	75°	80°	85°	90°	95°
1497	1492	1476	1448	1412	1376	1332	1247	1131	1012	881	740	593	437	292	169	80	30	16	15
100%	100%	99%	97%	94%	92%	89%	83%	76%	68%	59%	49%	40%	29%	20%	11%	5%	2%	1%	1%

**Intensities in 270° c-plane**

0°	5°	10°	15°	20°	25°	30°	35°	40°	45°	50°	55°	60°	65°	70°	75°	80°	85°	90°	95°
1497	1492	1476	1448	1412	1376	1332	1247	1131	1012	881	740	593	437	292	169	80	30	16	15
100%	100%	99%	97%	94%	92%	89%	83%	76%	68%	59%	49%	40%	29%	20%	11%	5%	2%	1%	1%

Beam angle 50%	Field angle 10%	Cutoff angle 2,5%	Intensity ratio in 120° cone	Intensity ratio in 90° cone
109,4°	151,8°	168,4°	81,6%	56,6%