

Эффективность света:

135 Lumen/Watt

Качество света:

CRI: 84,6

Цветовая температура:

4011 K

Поток: 24925 lm

Интенс.: 8662 cd

Мощн.: 184 W

КПД: 0,97

4 PLANES



Название продукта:

ViLED CC

M1-K-H-192-366.205.143-4-0-67

Дата и время:

19.12.2017 11:15:51

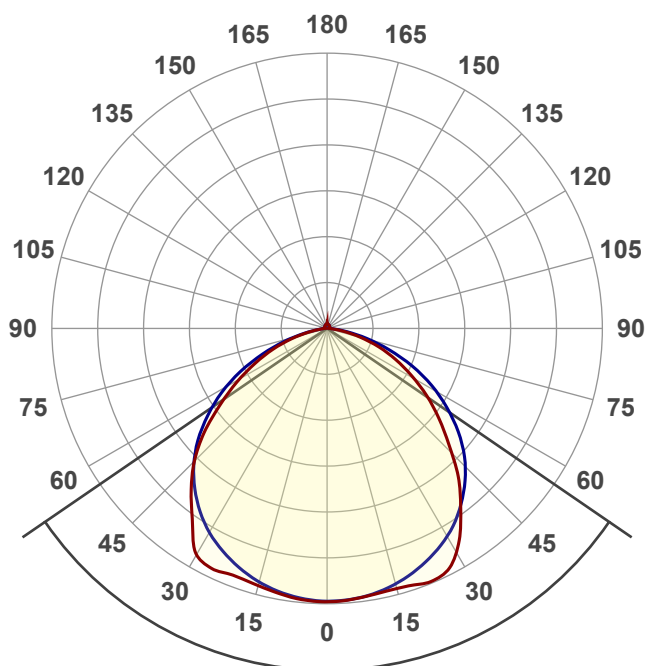

Угол пучка

111,1°

Цвет



CIE1931

x: 0,367

y: 0,360

Спектр

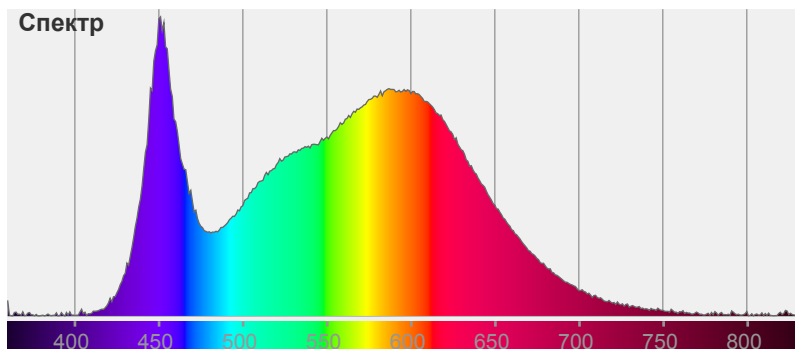

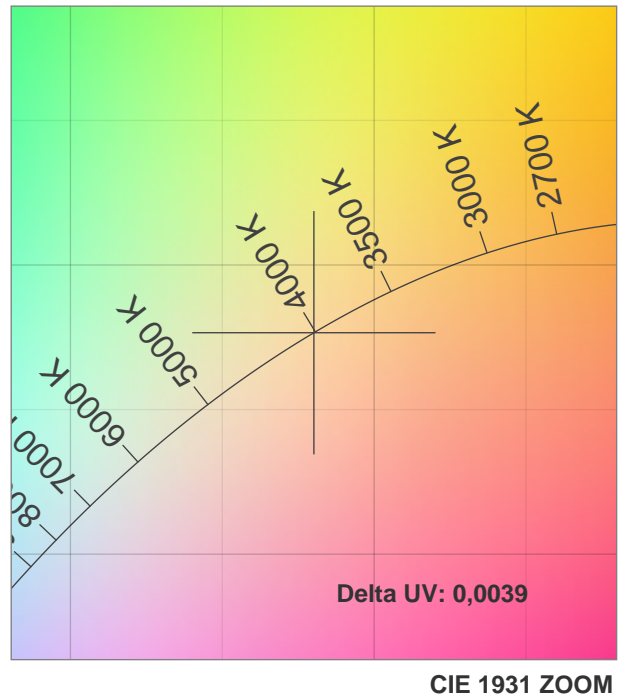
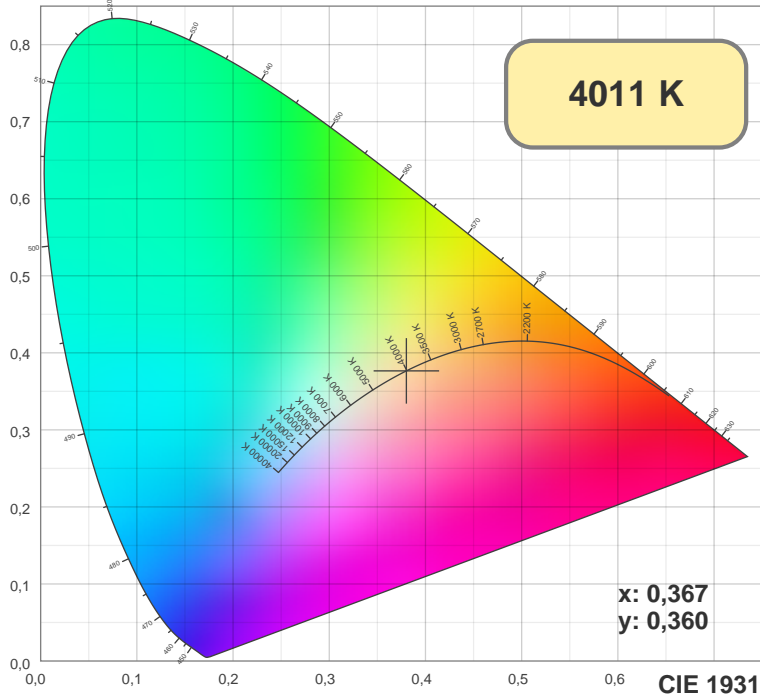

TM30: 82,2

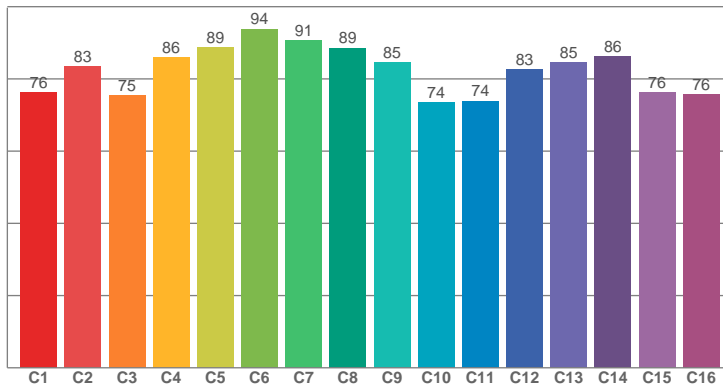

CRI: 84,6 (R1-R8)

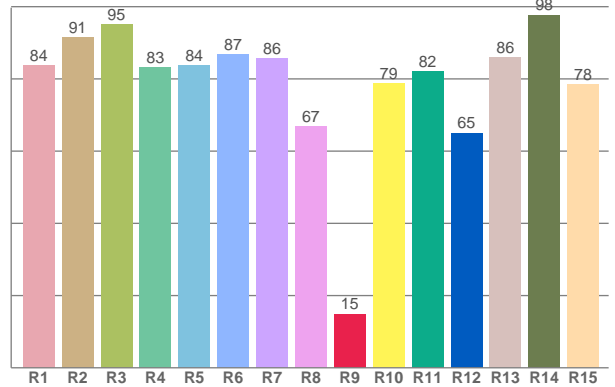

CRI R values, only R1-R8 are used to calculate final CRI value

R1	R2	R3	R4	R5	R6	R7	R8	R9	R10	R11	R12	R13	R14	R15
83,73	91,49	95,02	83,11	83,79	86,72	85,68	66,90	14,88	78,80	82,13	65,06	86,03	97,72	78,40

TM30 C values, 16 binned values out of total of 99 C values

C1	C2	C3	C4	C5	C6	C7	C8	C9	C10	C11	C12	C13	C14	C15	C16
76,17	83,36	75,44	85,97	88,80	93,81	90,58	88,57	84,65	73,57	73,89	82,68	84,60	86,18	76,22	75,64

CQS Q values

Q1	Q2	Q3	Q4	Q5	Q6	Q7	Q8	Q9	Q10	Q11	Q12	Q13	Q14	Q15
82,68	98,67	77,52	73,63	80,01	83,35	85,94	88,89	97,53	87,56	82,95	81,16	81,30	72,71	76,32

CQS: 81,8

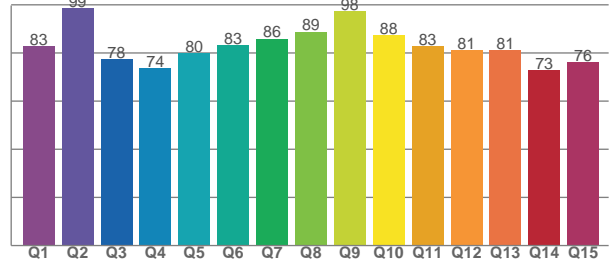

Color parameters

CCT	CRI	CRI R9	TM30 Rf	TM30 Rg	CQS	x	y	u	v	Duv
4011 K	84,6	14,9	82,2	95,9	81,8	0,4	0,4	0,2	0,3	0,0039

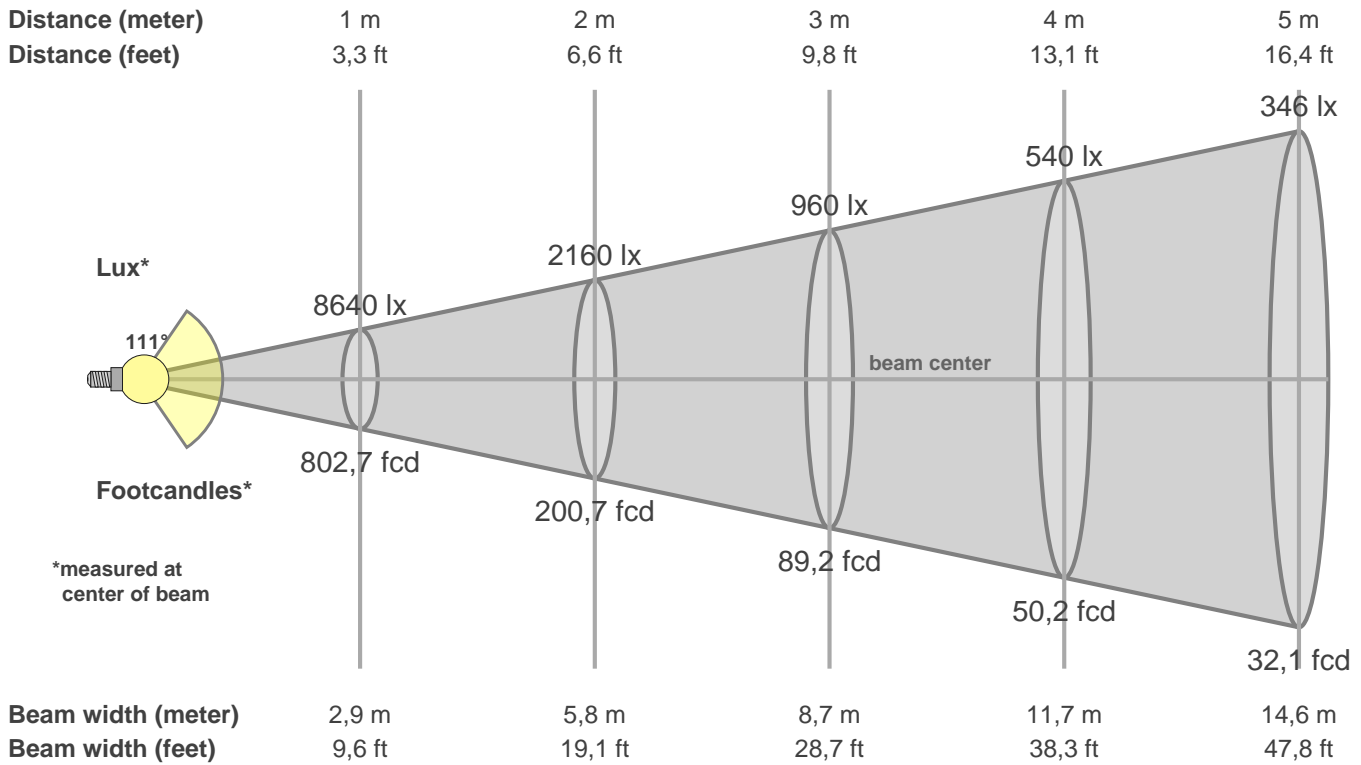

Intensities in 0° c-plane

0°	5°	10°	15°	20°	25°	30°	35°	40°	45°	50°	55°	60°	65°	70°	75°	80°	85°	90°	95°
8640	8616	8556	8537	8607	8579	8152	7375	6523	5594	4737	3959	3188	2469	1790	1111	547	181	68	67
100%	100%	99%	99%	100%	99%	94%	85%	75%	65%	55%	46%	37%	29%	21%	13%	6%	2%	1%	1%

Intensities in 90° c-plane

0°	5°	10°	15°	20°	25°	30°	35°	40°	45°	50°	55°	60°	65°	70°	75°	80°	85°	90°	95°
8640	8605	8519	8368	8161	7903	7593	7200	6724	6180	5533	4787	3995	3150	2260	1432	730	251	79	65
100%	100%	99%	97%	94%	91%	88%	83%	78%	72%	64%	55%	46%	36%	26%	17%	8%	3%	1%	1%

Intensities in 180° c-plane

0°	5°	10°	15°	20°	25°	30°	35°	40°	45°	50°	55°	60°	65°	70°	75°	80°	85°	90°	95°
8640	8621	8534	8433	8370	8422	8242	7440	6696	5944	5050	4070	3207	2409	1693	1027	494	186	94	84
100%	100%	99%	98%	97%	97%	95%	86%	77%	69%	58%	47%	37%	28%	20%	12%	6%	2%	1%	1%

Intensities in 270° c-plane

0°	5°	10°	15°	20°	25°	30°	35°	40°	45°	50°	55°	60°	65°	70°	75°	80°	85°	90°	95°
8640	8585	8478	8308	8076	7790	7457	7031	6528	5951	5275	4501	3685	2804	1929	1159	550	206	101	86
100%	99%	98%	96%	93%	90%	86%	81%	76%	69%	61%	52%	43%	32%	22%	13%	6%	2%	1%	1%

Beam angle 50%	Field angle 10%	Cutoff angle 2,5%	Intensity ratio in 120° cone	Intensity ratio in 90° cone
111,1°	154,3°	169,0°	80,9%	56,0%