

Эффективность света:

132 Lumen/Watt

Качество света:

CRI: 85,5

Цветовая температура:

4079 K

Поток: 8399 lm

Интенс.: 2890 cd

Мощн.: 63,6 W

КПД: 0,96

4 PLANES

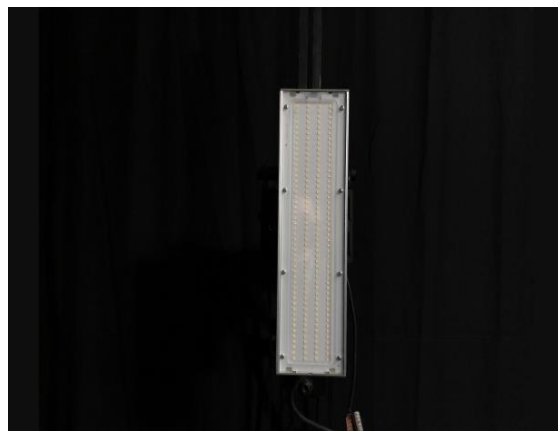

Название продукта:

ViLED CC

M1-U-H-64-366.100.173-4-0-67

Дата и время:

11.12.2017 11:57:34

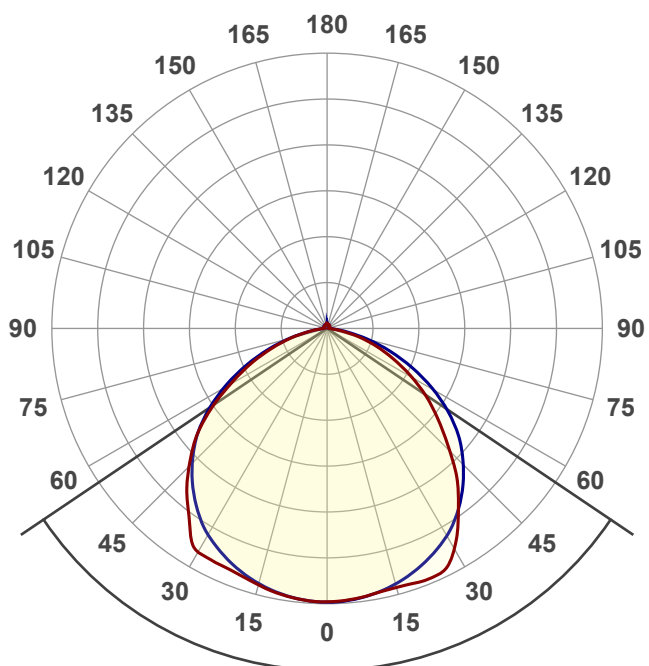

Угол пучка

112°

Цвет



CIE1931

x: 0,363

y: 0,354

Спектр

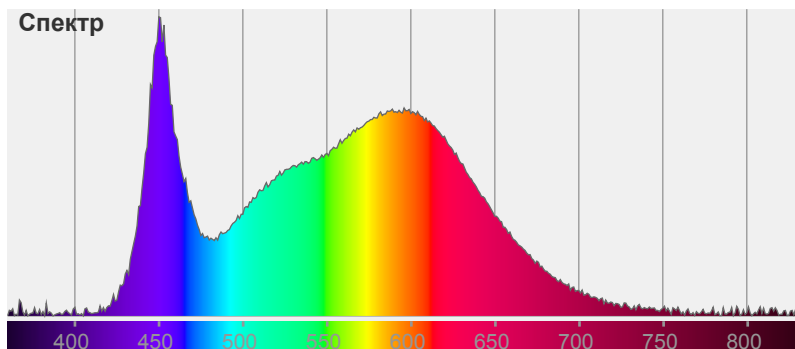

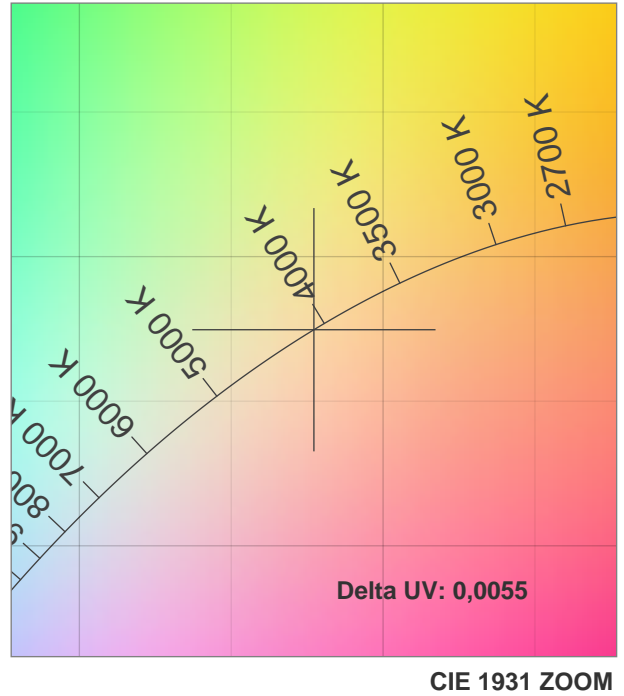
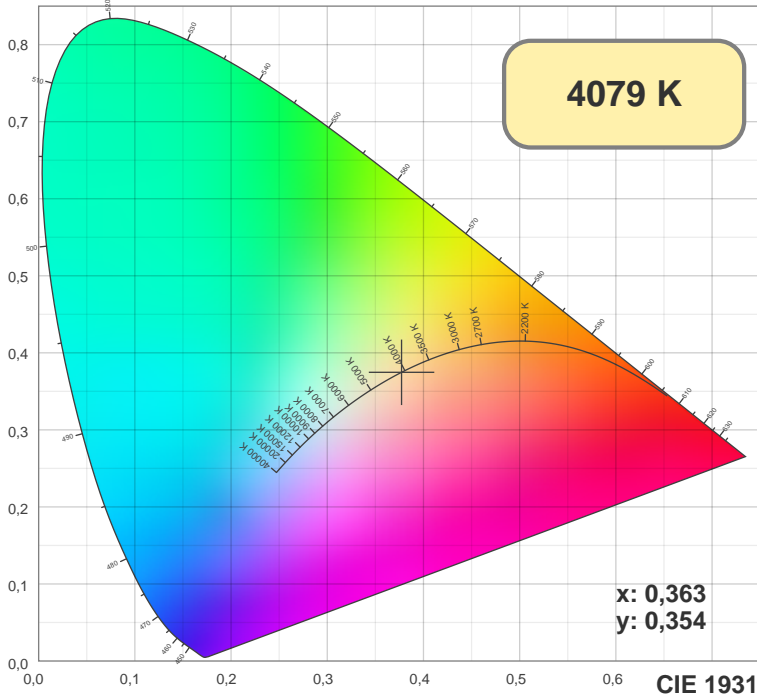

TM30: 82,5

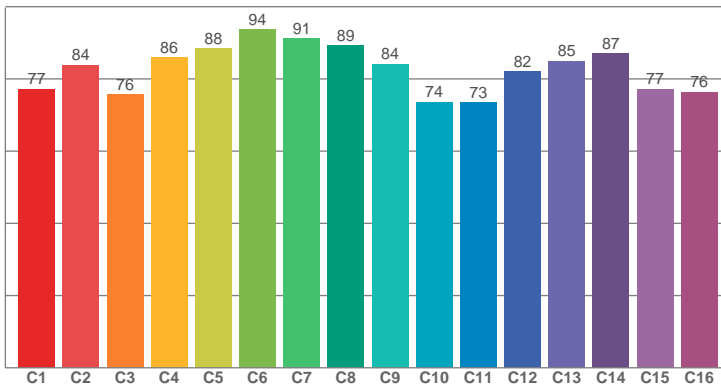

CRI: 85,5 (R1-R8)

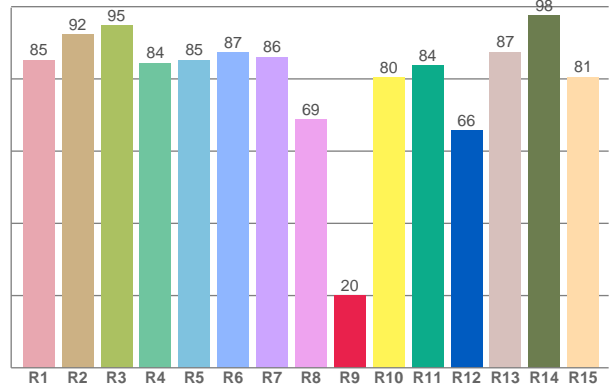

CRI R values, only R1-R8 are used to calculate final CRI value

R1	R2	R3	R4	R5	R6	R7	R8	R9	R10	R11	R12	R13	R14	R15
85,24	92,24	94,91	84,45	85,26	87,25	86,08	68,86	19,97	80,37	83,77	65,76	87,44	97,68	80,58

TM30 C values, 16 binned values out of total of 99 C values

C1	C2	C3	C4	C5	C6	C7	C8	C9	C10	C11	C12	C13	C14	C15	C16
77,25	83,86	75,68	85,85	88,47	93,70	91,20	89,22	84,14	73,60	73,49	82,13	84,96	87,09	77,24	76,39

CQS Q values

Q1	Q2	Q3	Q4	Q5	Q6	Q7	Q8	Q9	Q10	Q11	Q12	Q13	Q14	Q15
83,69	98,66	76,83	73,38	80,46	84,32	86,91	89,48	97,30	87,25	82,68	80,94	81,37	73,96	77,48

CQS: 82,1

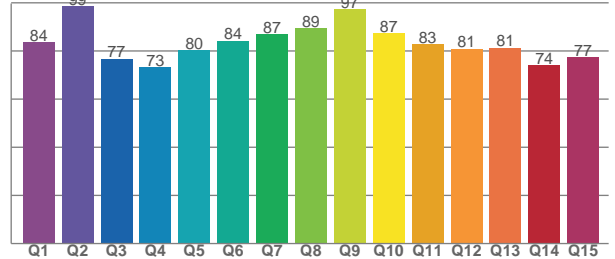

Color parameters

CCT	CRI	CRI R9	TM30 Rf	TM30 Rg	CQS	x	y	u	v	Duv
4079 K	85,5	20,0	82,5	96,6	82,1	0,4	0,4	0,2	0,3	0,0055

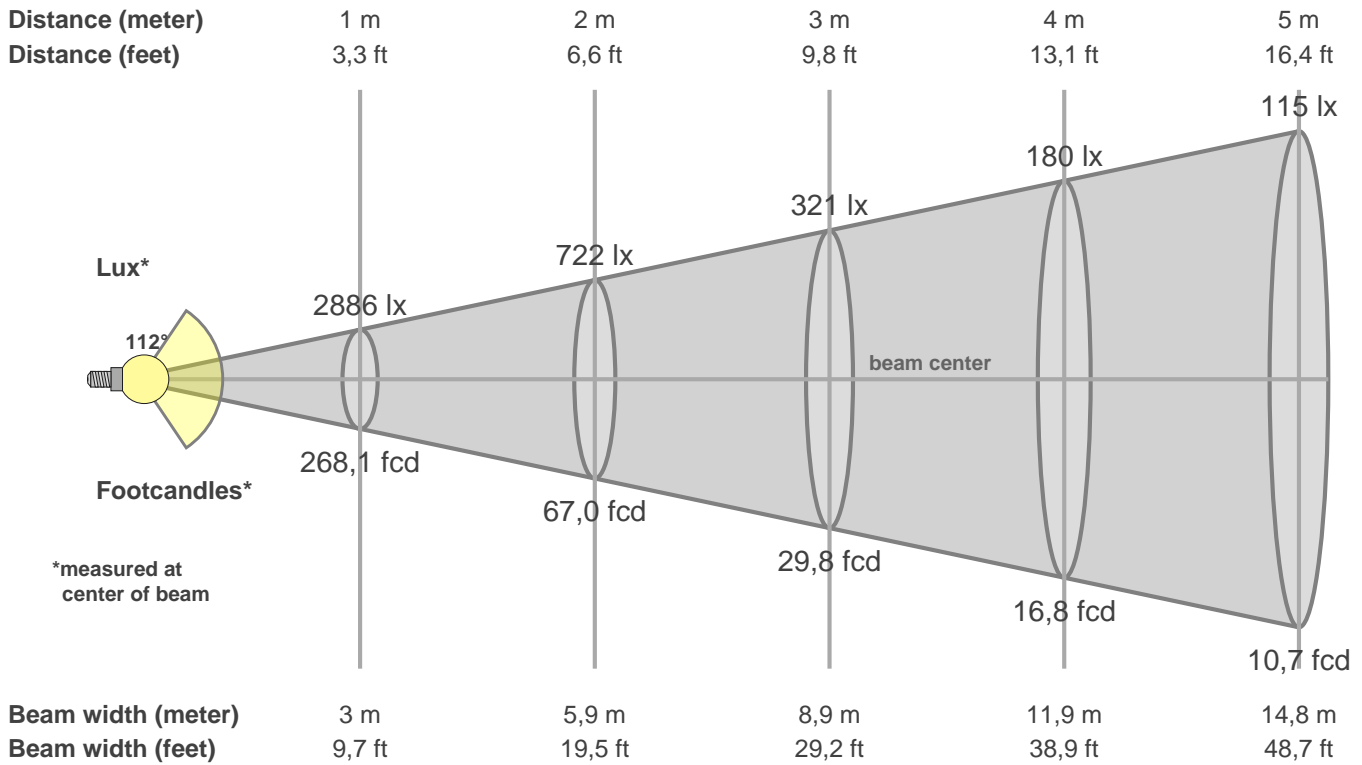

Intensities in 0° c-plane

0°	5°	10°	15°	20°	25°	30°	35°	40°	45°	50°	55°	60°	65°	70°	75°	80°	85°	90°	95°
2886	2873	2848	2836	2848	2834	2678	2417	2144	1837	1553	1299	1039	785	561	352	162	55	23	23
100%	100%	99%	98%	99%	98%	93%	84%	74%	64%	54%	45%	36%	27%	19%	12%	6%	2%	1%	1%

Intensities in 90° c-plane

0°	5°	10°	15°	20°	25°	30°	35°	40°	45°	50°	55°	60°	65°	70°	75°	80°	85°	90°	95°
2886	2878	2845	2792	2721	2633	2527	2389	2223	2033	1826	1577	1298	1004	714	448	219	76	25	22
100%	100%	99%	97%	94%	91%	88%	83%	77%	70%	63%	55%	45%	35%	25%	16%	8%	3%	1%	1%

Intensities in 180° c-plane

0°	5°	10°	15°	20°	25°	30°	35°	40°	45°	50°	55°	60°	65°	70°	75°	80°	85°	90°	95°
2886	2877	2849	2805	2762	2739	2712	2529	2302	2062	1811	1509	1184	899	633	402	203	82	41	36
100%	100%	99%	97%	96%	95%	94%	88%	80%	71%	63%	52%	41%	31%	22%	14%	7%	3%	1%	1%

Intensities in 270° c-plane

0°	5°	10°	15°	20°	25°	30°	35°	40°	45°	50°	55°	60°	65°	70°	75°	80°	85°	90°	95°
2886	2876	2842	2788	2714	2622	2513	2371	2202	2012	1801	1547	1263	968	683	422	205	79	39	38
100%	100%	98%	97%	94%	91%	87%	82%	76%	70%	62%	54%	44%	34%	24%	15%	7%	3%	1%	1%

Beam angle 50%	Field angle 10%	Cutoff angle 2,5%	Intensity ratio in 120° cone	Intensity ratio in 90° cone
112,0°	155,0°	170,5°	80,3%	55,3%