

Эффективность света:

142 Lumen/Watt

Качество света:

CRI: 86,0

Цветовая температура:

4039 K

Поток: 6544 lm

Интенс.: 3152 cd

Мощн.: 46,0 W

КПД: 0,91

4 PLANES

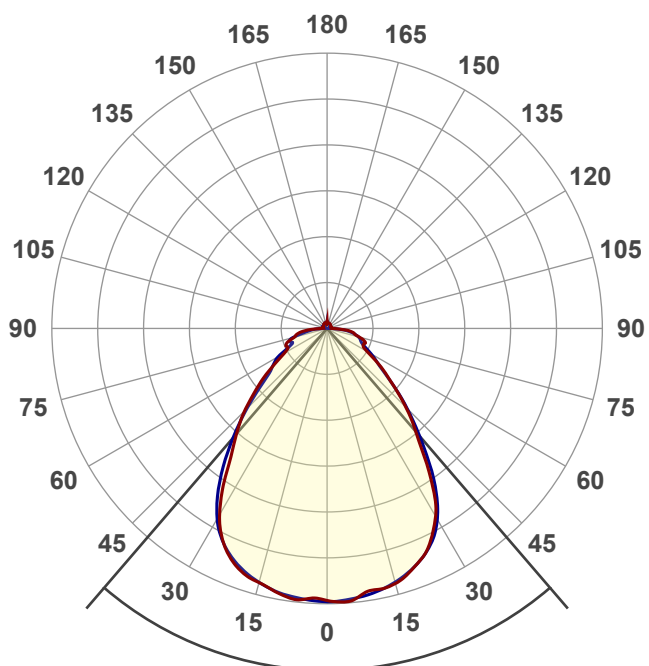

Угол пучка

81,4°

Цвет



CIE1931

x: 0,363

y: 0,356

Спектр

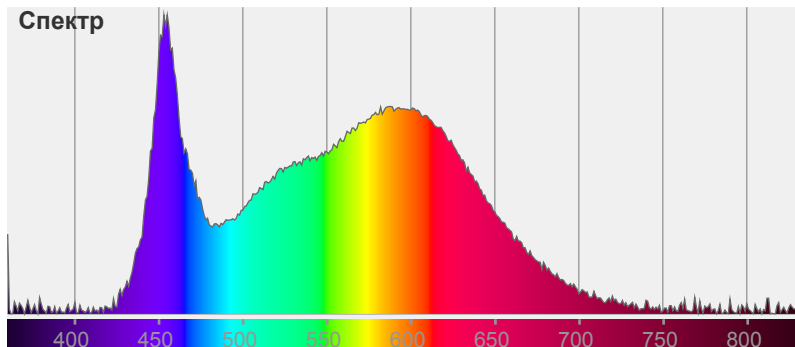

Название продукта:

ViLED CC

03-Y-C-48-1190.130.15-4-0-65

Дата и время:

05.12.2017 14:18:32

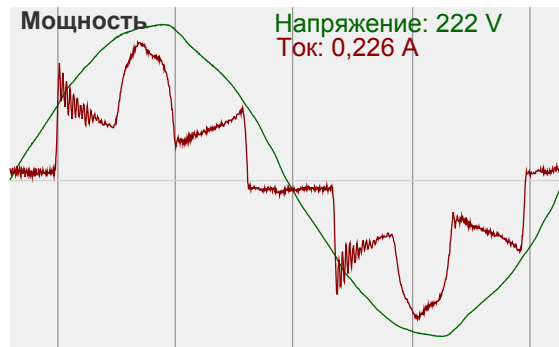

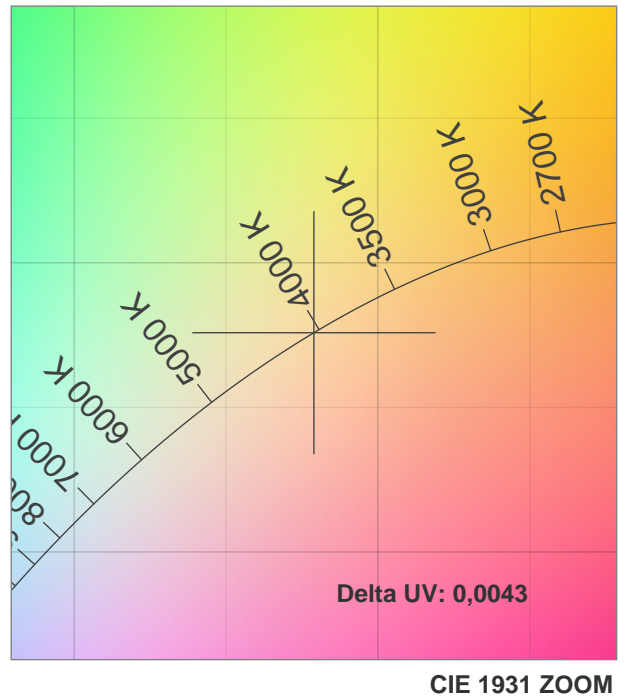
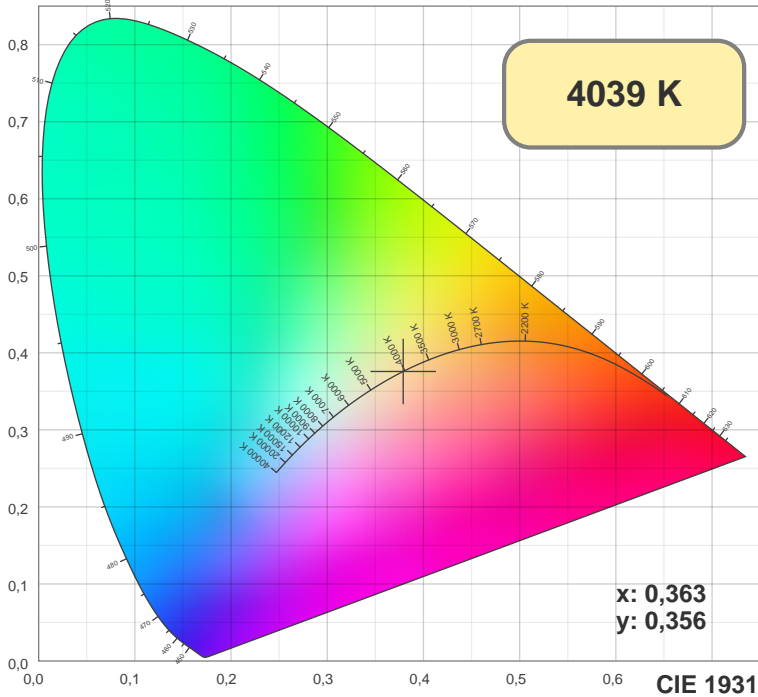

TM30: 82,3

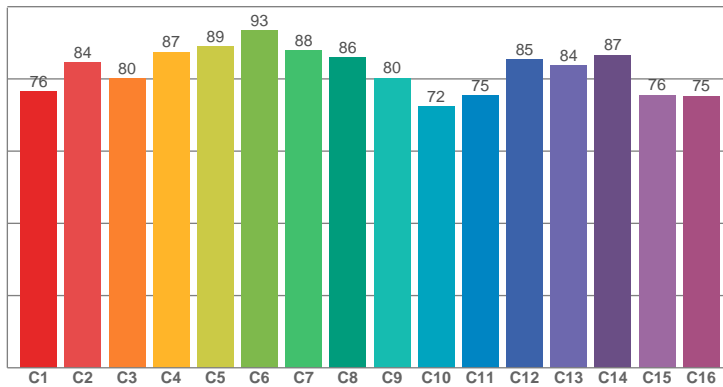

CRI: 86,0 (R1-R8)

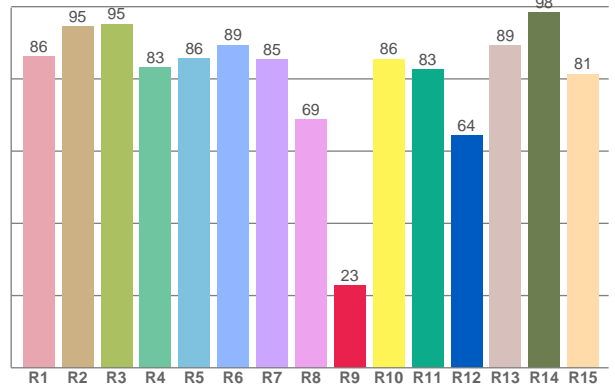

CRI R values, only R1-R8 are used to calculate final CRI value

R1	R2	R3	R4	R5	R6	R7	R8	R9	R10	R11	R12	R13	R14	R15
86,20	94,60	95,23	83,19	85,57	89,42	85,32	68,77	22,75	85,53	82,61	64,28	89,20	98,47	81,35

TM30 C values, 16 binned values out of total of 99 C values

C1	C2	C3	C4	C5	C6	C7	C8	C9	C10	C11	C12	C13	C14	C15	C16
76,47	84,50	80,18	87,45	89,06	93,33	87,89	85,92	80,27	72,38	75,37	85,43	83,67	86,60	75,59	75,25

CQS Q values

Q1	Q2	Q3	Q4	Q5	Q6	Q7	Q8	Q9	Q10	Q11	Q12	Q13	Q14	Q15
82,31	97,65	80,02	73,93	79,16	82,58	86,91	89,55	98,11	90,41	85,33	83,07	82,81	75,18	78,02

CQS: 82,9

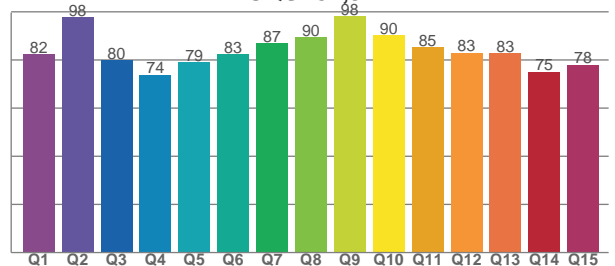

Color parameters

CCT	CRI	CRI R9	TM30 Rf	TM30 Rg	CQS	x	y	u	v	Duv
4039 K	86,0	22,8	82,3	94,6	82,9	0,4	0,4	0,2	0,3	0,0043

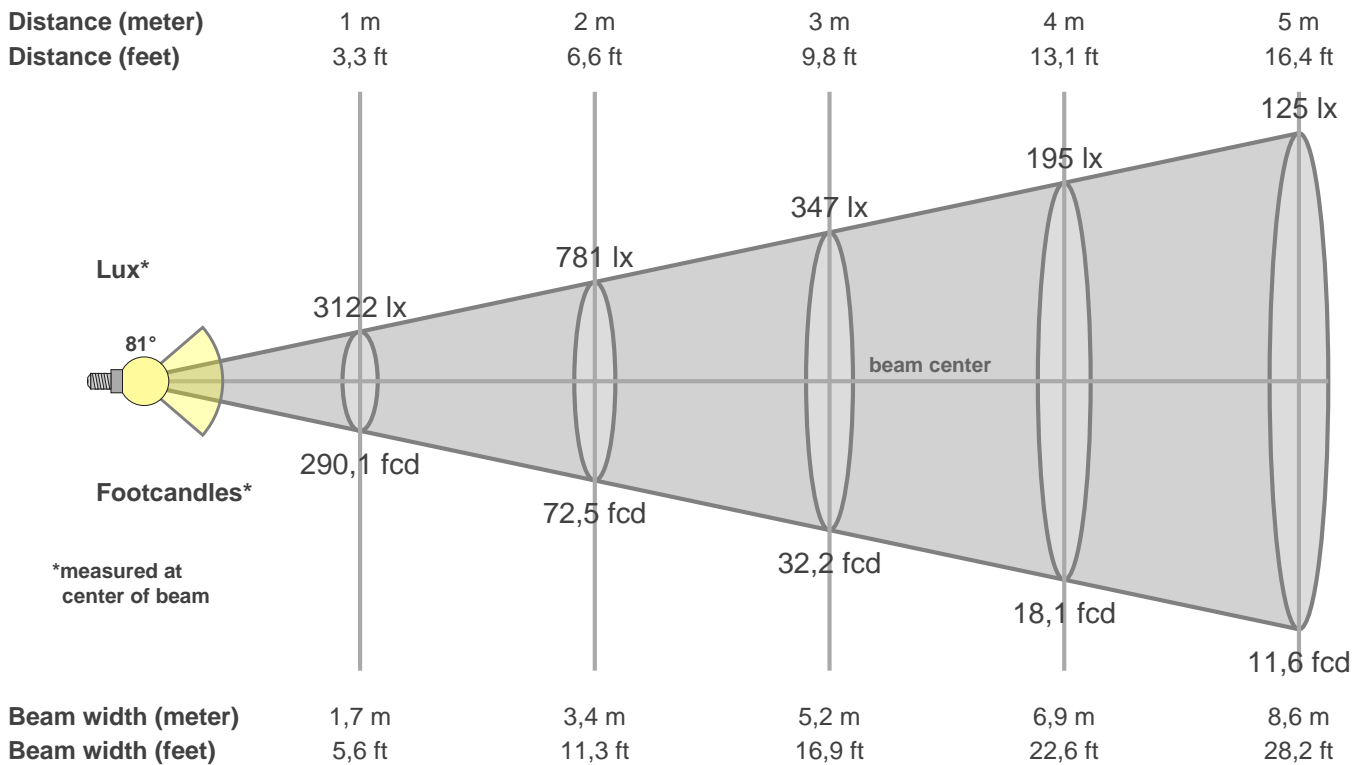

Intensities in 0° c-plane

0°	5°	10°	15°	20°	25°	30°	35°	40°	45°	50°	55°	60°	65°	70°	75°	80°	85°	90°	95°
3122	3137	3050	3023	2915	2750	2477	2057	1612	1280	967	737	541	461	464	385	311	223	78	53
100%	100%	98%	97%	93%	88%	79%	66%	52%	41%	31%	24%	17%	15%	15%	12%	10%	7%	3%	2%

Intensities in 90° c-plane

0°	5°	10°	15°	20°	25°	30°	35°	40°	45°	50°	55°	60°	65°	70°	75°	80°	85°	90°	95°
3122	3115	3077	3010	2913	2763	2518	2141	1689	1302	964	725	584	466	409	368	296	187	51	23
100%	100%	99%	96%	93%	88%	81%	69%	54%	42%	31%	23%	19%	15%	13%	12%	9%	6%	2%	1%

Intensities in 180° c-plane

0°	5°	10°	15°	20°	25°	30°	35°	40°	45°	50°	55°	60°	65°	70°	75°	80°	85°	90°	95°
3122	3117	3093	3017	2936	2766	2460	2014	1637	1338	1038	771	568	506	487	389	337	229	69	57
100%	100%	99%	97%	94%	89%	79%	65%	52%	43%	33%	25%	18%	16%	16%	12%	11%	7%	2%	2%

Intensities in 270° c-plane

0°	5°	10°	15°	20°	25°	30°	35°	40°	45°	50°	55°	60°	65°	70°	75°	80°	85°	90°	95°
3122	3114	3082	3013	2911	2760	2516	2144	1714	1304	962	769	646	475	451	409	262	162	44	28
100%	100%	99%	96%	93%	88%	81%	69%	55%	42%	31%	25%	21%	15%	14%	13%	8%	5%	1%	1%

Beam angle 50%	Field angle 10%	Cutoff angle 2,5%	Intensity ratio in 120° cone	Intensity ratio in 90° cone
81,4°	152,0°	177,3°	80,4%	65,0%