

Эффективность света:

138 Lumen/Watt

Качество света:

CRI: 85,8

Цветовая температура:

4063 K

Поток: 4778 lm

Интенс.: 2382 cd

Мощн.: 34,5 W

КПД: 0,90

4 PLANES



Название продукта:

ViLED CC

03-Y-C-36-1190.130.15-4-0-65

Дата и время:

06.12.2017 15:33:30

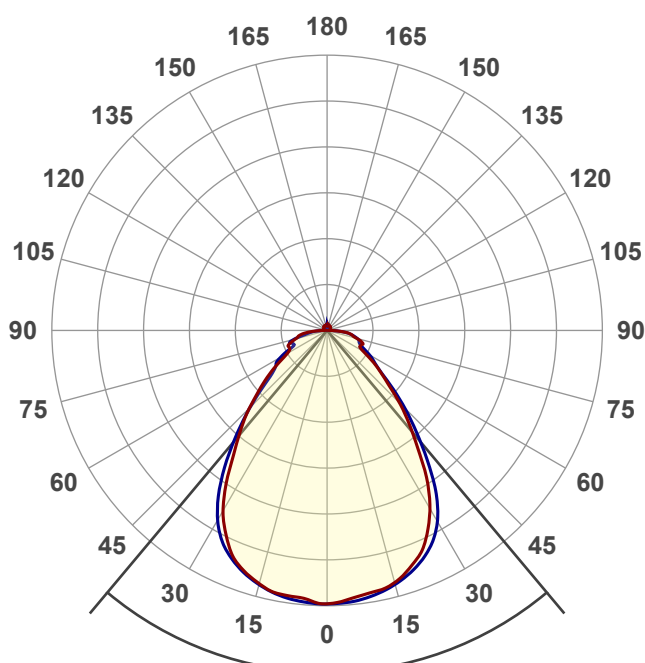

Угол пучка

80°

Цвет



CIE1931

x: 0,364

y: 0,358

Спектр

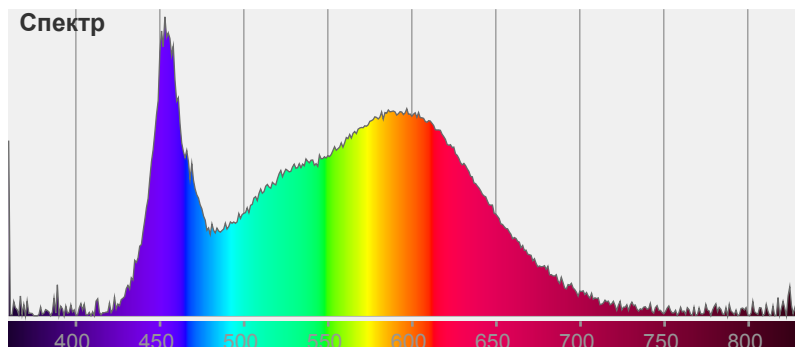

Мощность

Напряжение: 222 V

Ток: 0,172 A

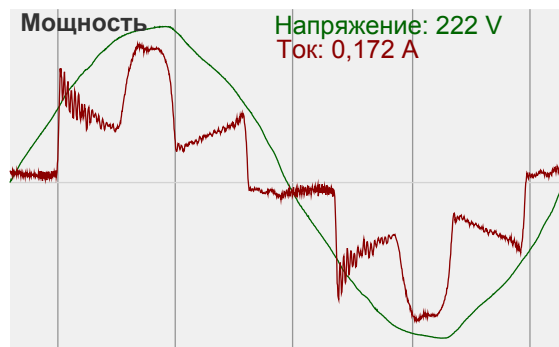

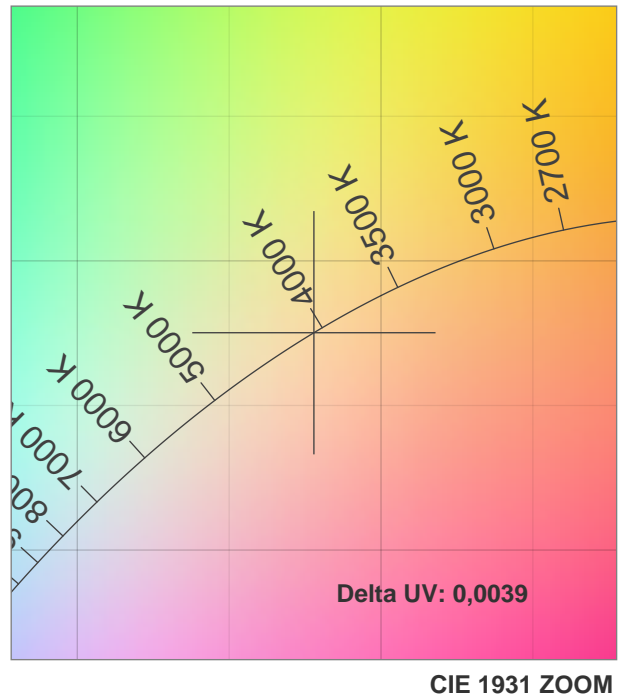
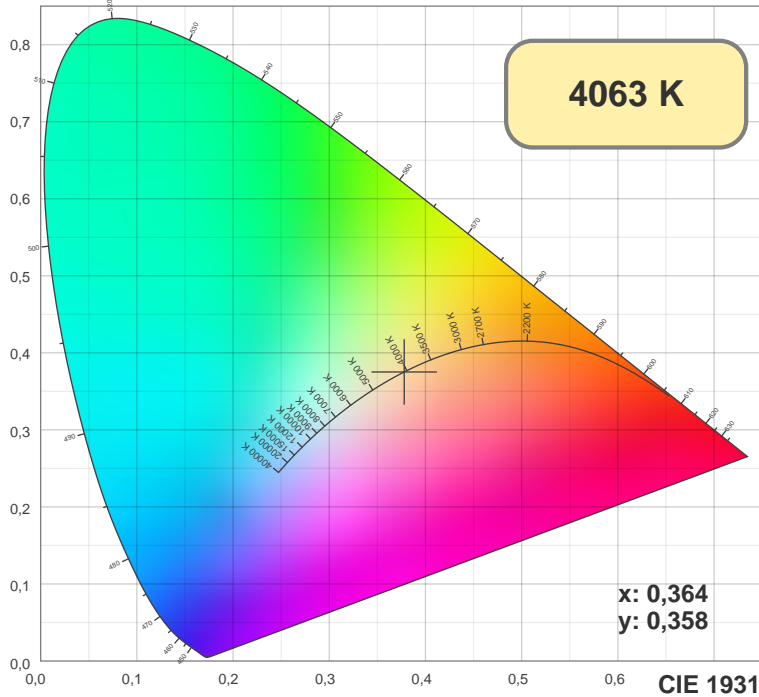

TM30: 82,2

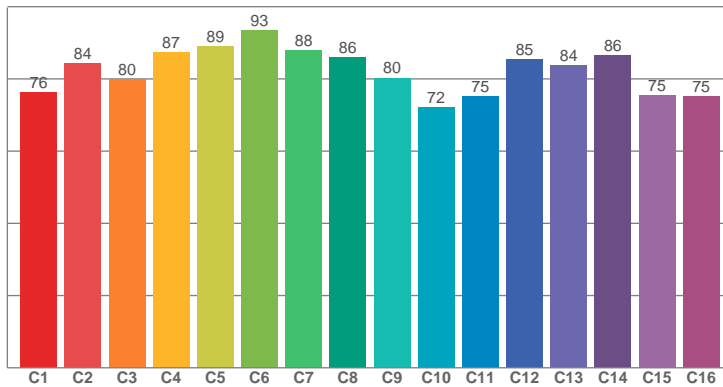

CRI: 85,8 (R1-R8)

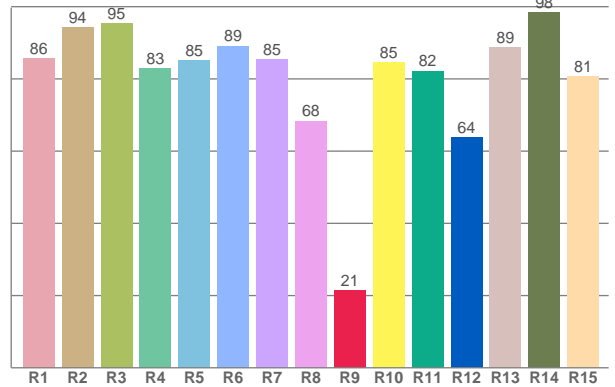

CRI R values, only R1-R8 are used to calculate final CRI value

R1	R2	R3	R4	R5	R6	R7	R8	R9	R10	R11	R12	R13	R14	R15
85,73	94,20	95,31	82,91	85,12	89,12	85,34	68,35	21,41	84,61	82,22	63,75	88,68	98,45	80,74

TM30 C values, 16 binned values out of total of 99 C values

C1	C2	C3	C4	C5	C6	C7	C8	C9	C10	C11	C12	C13	C14	C15	C16
76,27	84,32	79,79	87,29	89,03	93,33	87,94	85,96	80,29	72,17	75,13	85,30	83,71	86,42	75,47	75,13

CQS Q values

Q1	Q2	Q3	Q4	Q5	Q6	Q7	Q8	Q9	Q10	Q11	Q12	Q13	Q14	Q15
82,20	97,68	79,79	73,76	79,02	82,40	86,61	89,38	98,05	90,23	85,19	83,01	82,74	74,85	77,78

CQS: 82,7

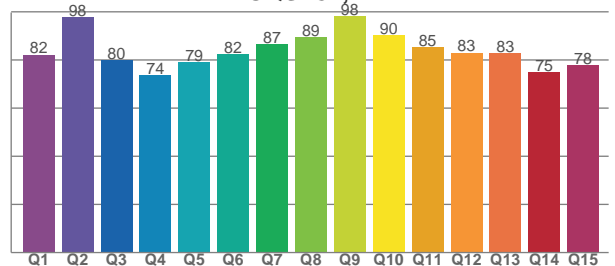

Color parameters

CCT	CRI	CRI R9	TM30 Rf	TM30 Rg	CQS	x	y	u	v	Duv
4063 K	85,8	21,4	82,2	94,5	82,7	0,4	0,4	0,2	0,3	0,0039

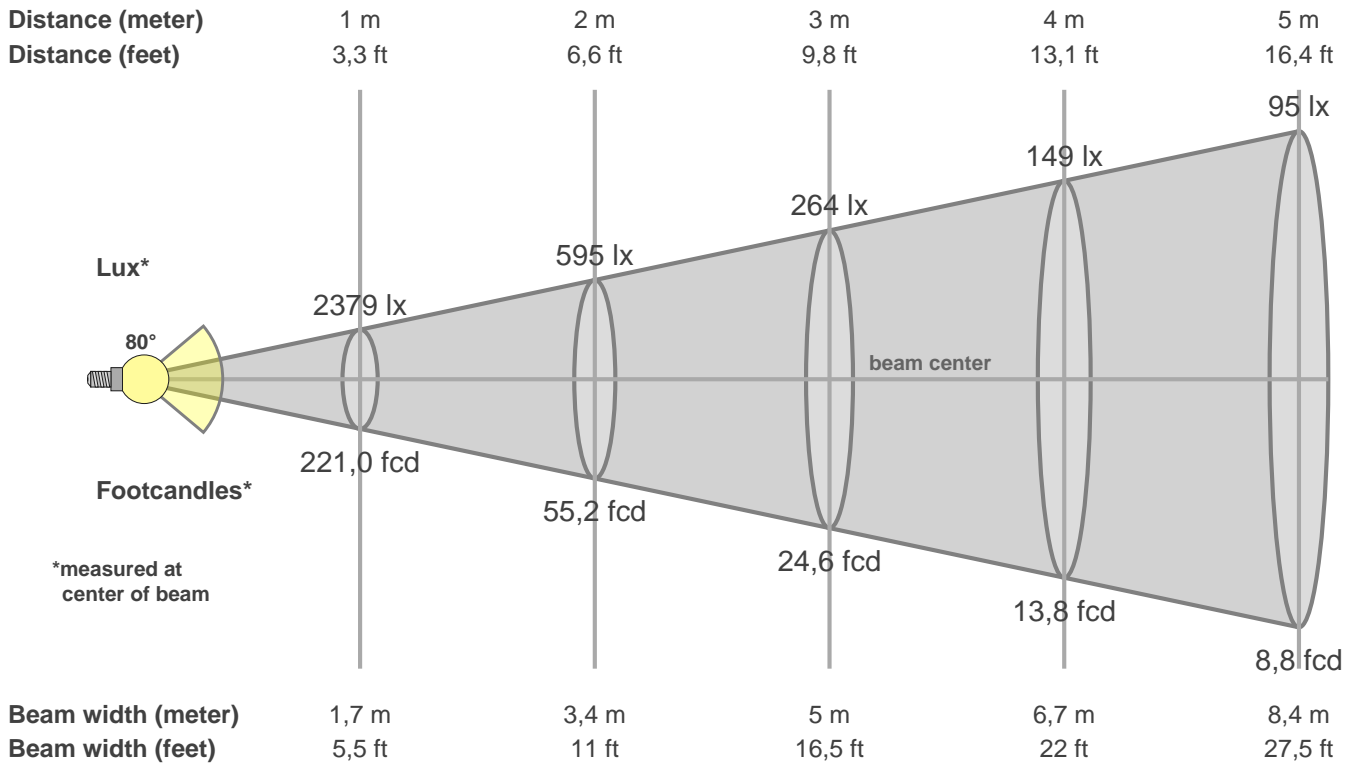

Intensities in 0° c-plane

0°	5°	10°	15°	20°	25°	30°	35°	40°	45°	50°	55°	60°	65°	70°	75°	80°	85°	90°	95°
2379	2345	2312	2270	2170	2019	1789	1480	1157	893	663	504	369	321	330	269	218	144	42	30
100%	99%	97%	95%	91%	85%	75%	62%	49%	38%	28%	21%	16%	13%	14%	11%	9%	6%	2%	1%

Intensities in 90° c-plane

0°	5°	10°	15°	20°	25°	30°	35°	40°	45°	50°	55°	60°	65°	70°	75°	80°	85°	90°	95°
2379	2372	2341	2288	2213	2097	1917	1623	1268	959	696	521	428	338	297	271	216	134	32	14
100%	100%	98%	96%	93%	88%	81%	68%	53%	40%	29%	22%	18%	14%	12%	11%	9%	6%	1%	1%

Intensities in 180° c-plane

0°	5°	10°	15°	20°	25°	30°	35°	40°	45°	50°	55°	60°	65°	70°	75°	80°	85°	90°	95°
2379	2341	2330	2282	2193	2038	1811	1487	1195	958	738	552	407	362	350	285	242	156	43	34
100%	98%	98%	96%	92%	86%	76%	63%	50%	40%	31%	23%	17%	15%	15%	12%	10%	7%	2%	1%

Intensities in 270° c-plane

0°	5°	10°	15°	20°	25°	30°	35°	40°	45°	50°	55°	60°	65°	70°	75°	80°	85°	90°	95°
2379	2373	2344	2291	2210	2092	1905	1612	1268	951	685	548	466	329	326	295	186	118	31	19
100%	100%	99%	96%	93%	88%	80%	68%	53%	40%	29%	23%	20%	14%	14%	12%	8%	5%	1%	1%

Beam angle 50%	Field angle 10%	Cutoff angle 2,5%	Intensity ratio in 120° cone	Intensity ratio in 90° cone
80,0°	149,7°	175,8°	81,1%	66,0%