

Эффективность света:

142 Lumen/Watt

Качество света:

CRI: 85,9

Цветовая температура:

4091 K

Поток: 4912 lm

Интенс.: 1875 cd

Мощн.: 34,5 W

КПД: 0,90

4 PLANES



Название продукта:

ViLED CC

03-У-К-36-1190.130.15-4-0-65

Дата и время:

06.12.2017 11:17:51

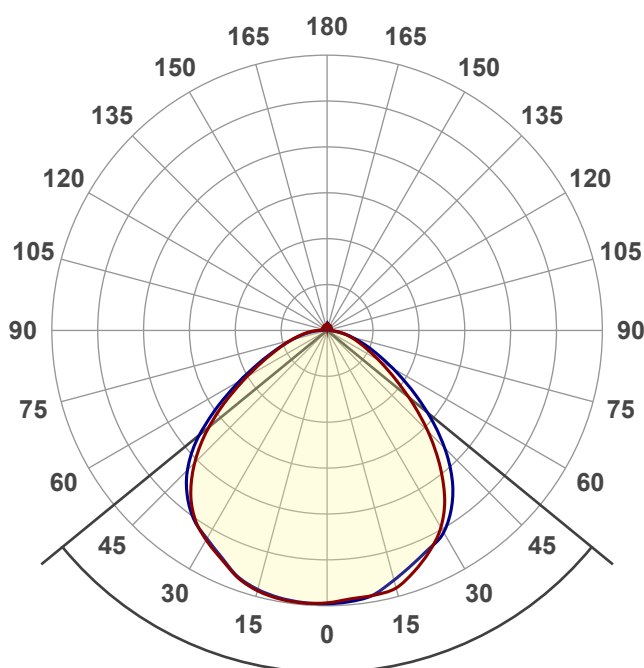

Угол пучка

101,4°

Цвет



CIE1931

x: 0,363

y: 0,357

Спектр

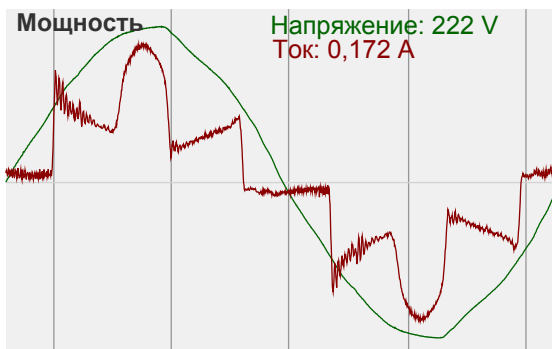
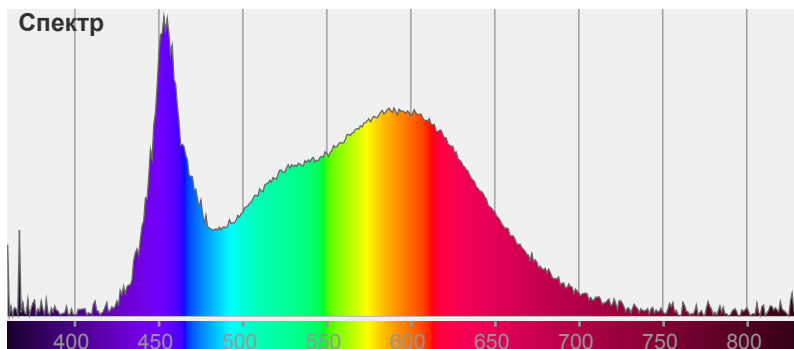

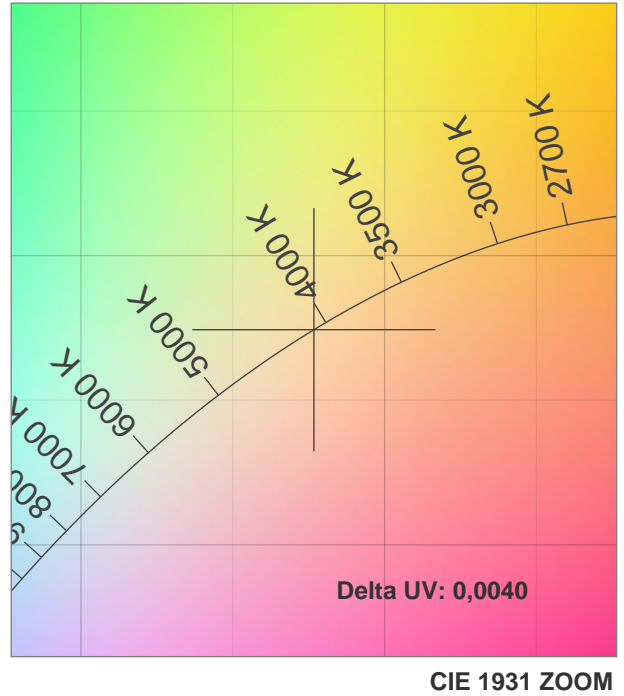
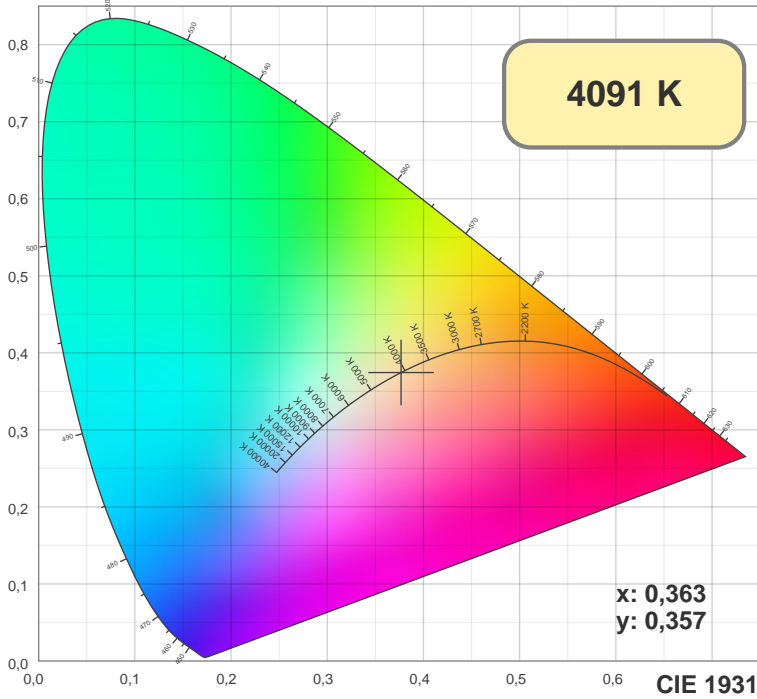

TM30: 82,3

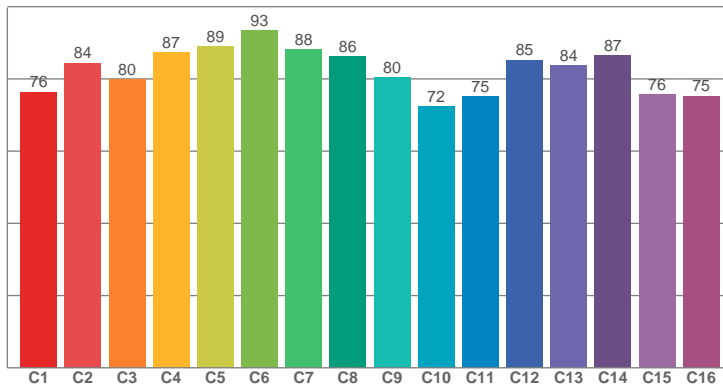

CRI: 85,9 (R1-R8)

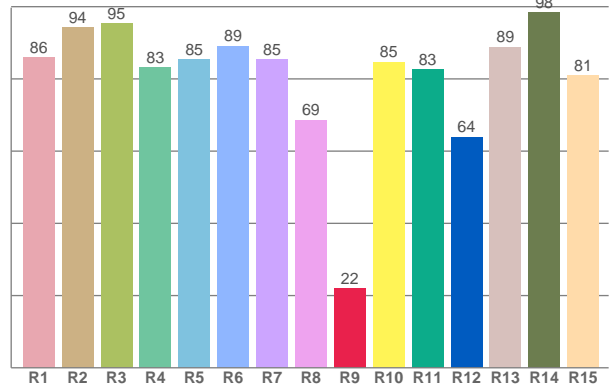

CRI R values, only R1-R8 are used to calculate final CRI value

R1	R2	R3	R4	R5	R6	R7	R8	R9	R10	R11	R12	R13	R14	R15
85,90	94,25	95,32	83,14	85,31	89,14	85,45	68,63	21,95	84,74	82,53	63,93	88,83	98,46	80,96

TM30 C values, 16 binned values out of total of 99 C values

C1	C2	C3	C4	C5	C6	C7	C8	C9	C10	C11	C12	C13	C14	C15	C16
76,43	84,41	79,84	87,34	89,09	93,40	88,11	86,13	80,46	72,32	75,16	85,29	83,81	86,56	75,63	75,26

CQS Q values

Q1	Q2	Q3	Q4	Q5	Q6	Q7	Q8	Q9	Q10	Q11	Q12	Q13	Q14	Q15
82,33	97,75	79,78	73,83	79,16	82,58	86,80	89,49	98,07	90,20	85,20	83,02	82,78	74,97	77,90

CQS: 82,8

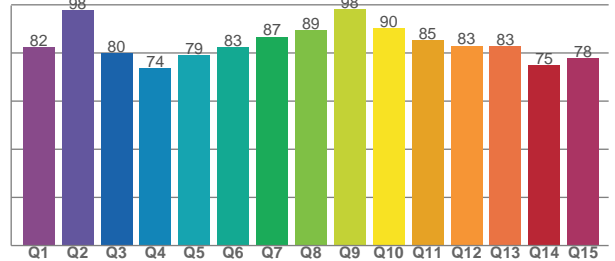

Color parameters

CCT	CRI	CRI R9	TM30 Rf	TM30 Rg	CQS	x	y	u	v	Duv
4091 K	85,9	21,9	82,3	94,6	82,8	0,4	0,4	0,2	0,3	0,0040

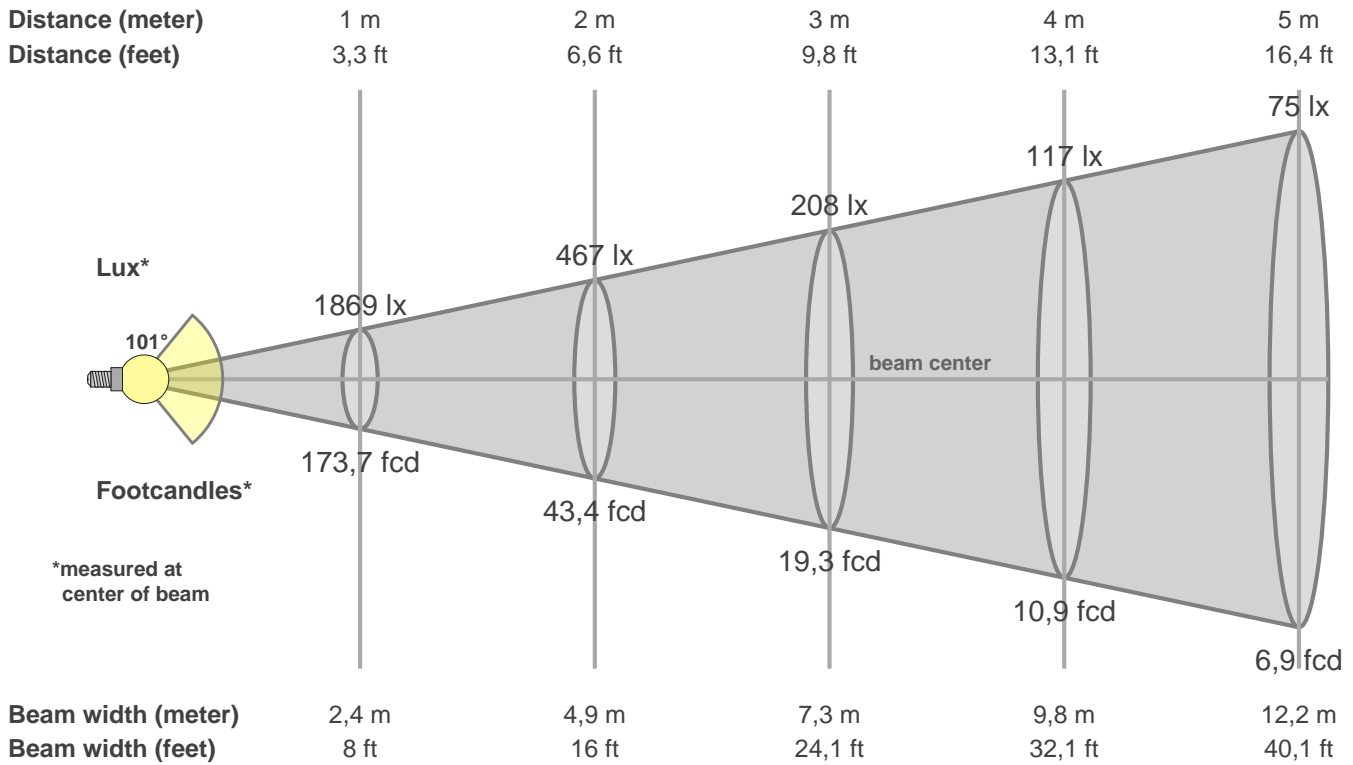

Intensities in 0° c-plane

0°	5°	10°	15°	20°	25°	30°	35°	40°	45°	50°	55°	60°	65°	70°	75°	80°	85°	90°	95°
1869	1845	1841	1825	1752	1664	1557	1402	1198	976	755	561	413	302	223	161	105	55	29	30
100%	99%	98%	98%	94%	89%	83%	75%	64%	52%	40%	30%	22%	16%	12%	9%	6%	3%	2%	2%

Intensities in 90° c-plane

0°	5°	10°	15°	20°	25°	30°	35°	40°	45°	50°	55°	60°	65°	70°	75°	80°	85°	90°	95°
1869	1862	1836	1770	1707	1650	1593	1482	1330	1137	921	708	524	376	265	176	107	50	17	16
100%	100%	98%	95%	91%	88%	85%	79%	71%	61%	49%	38%	28%	20%	14%	9%	6%	3%	1%	1%

Intensities in 180° c-plane

0°	5°	10°	15°	20°	25°	30°	35°	40°	45°	50°	55°	60°	65°	70°	75°	80°	85°	90°	95°
1869	1873	1867	1844	1797	1723	1656	1574	1450	1280	1077	852	639	471	348	259	185	125	70	34
100%	100%	100%	99%	96%	92%	89%	84%	78%	68%	58%	46%	34%	25%	19%	14%	10%	7%	4%	2%

Intensities in 270° c-plane

0°	5°	10°	15°	20°	25°	30°	35°	40°	45°	50°	55°	60°	65°	70°	75°	80°	85°	90°	95°
1869	1870	1859	1836	1792	1712	1646	1585	1487	1351	1162	922	691	500	356	251	170	101	48	22
100%	100%	99%	98%	96%	92%	88%	85%	80%	72%	62%	49%	37%	27%	19%	13%	9%	5%	3%	1%

Beam angle 50%	Field angle 10%	Cutoff angle 2,5%	Intensity ratio in 120° cone	Intensity ratio in 90° cone
101,4°	152,8°	177,4°	81,2%	58,6%