

Эффективность света:

131 Lumen/Watt

Качество света:

CRI: 85,2

Цветовая температура:

4058 K

Поток: 3049 lm

Интенс.: 1513 cd

Мощн.: 23,3 W

КПД: 0,91

4 PLANES



Название продукта:

VILED CC

01-Y-C-24-590.590.15-4-0-65

Дата и время:

06.11.2017 11:57:18

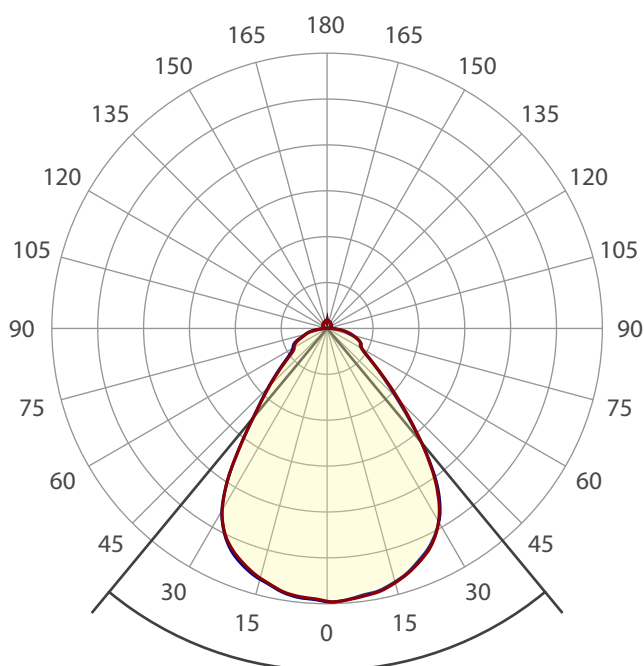

Угол пучка

79,2°

Цвет



CIE1931

x: 0,365

y: 0,360

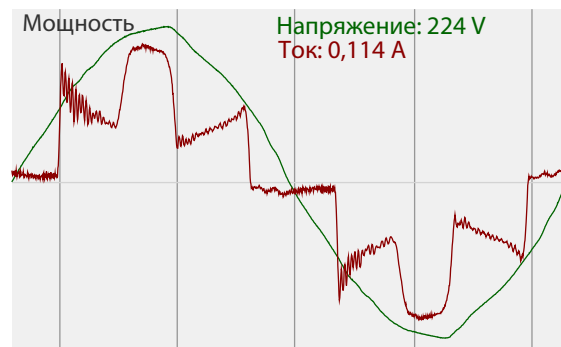
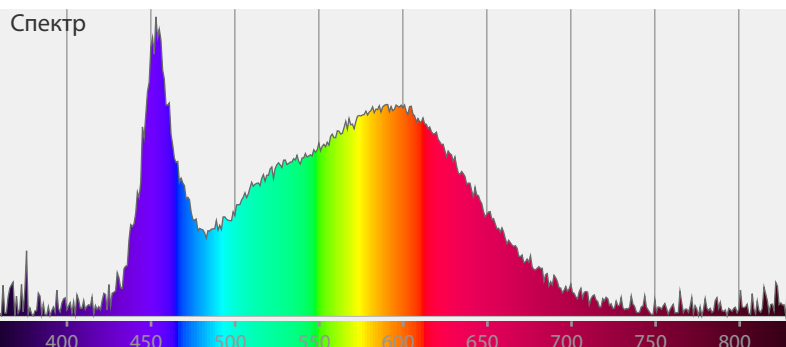

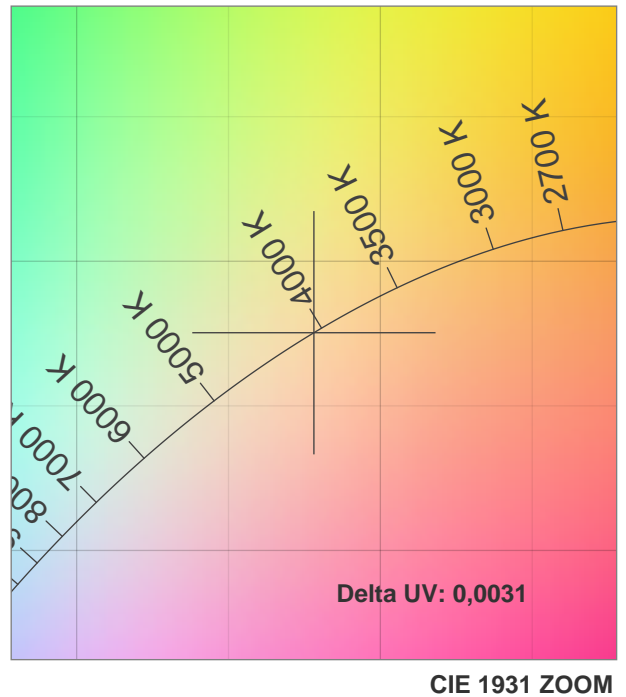
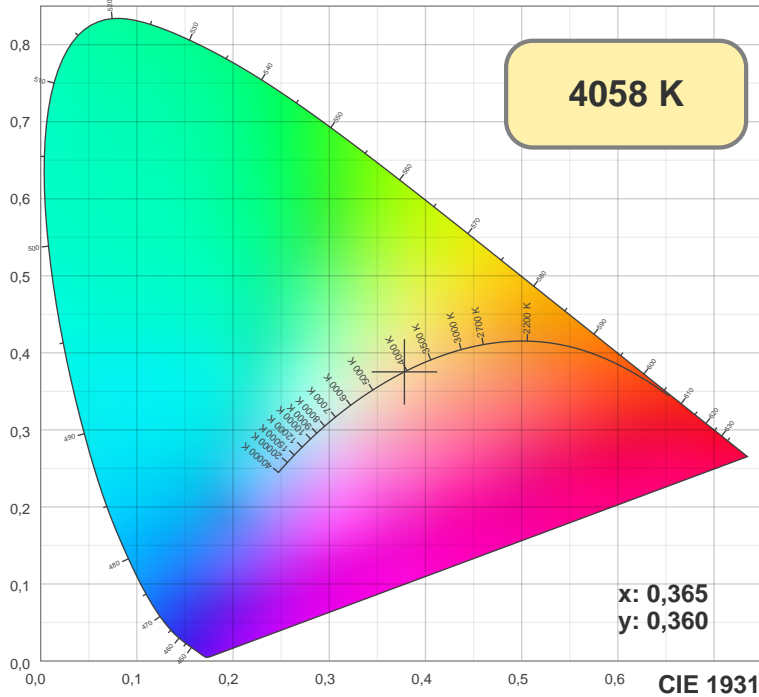

TM30: 82,4

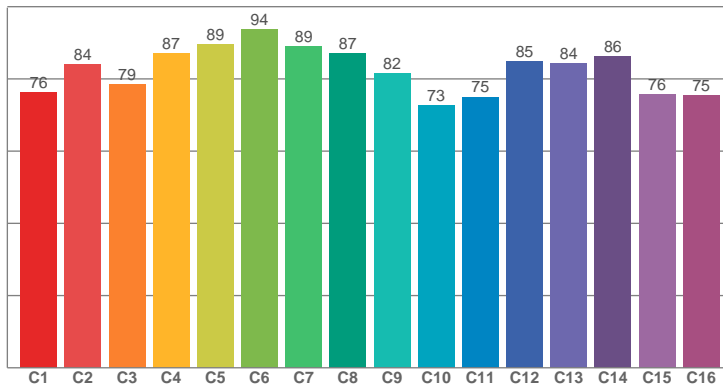

CRI: 85,2 (R1-R8)

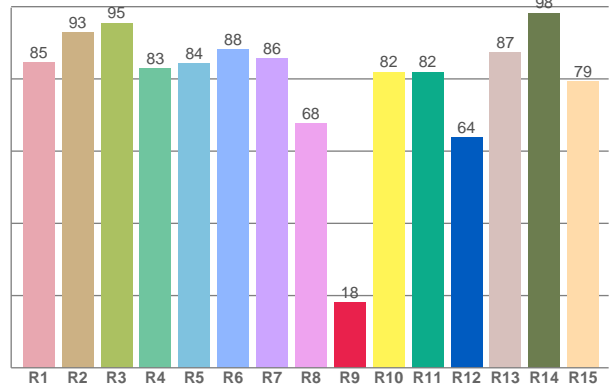

CRI R values, only R1-R8 are used to calculate final CRI value

R1	R2	R3	R4	R5	R6	R7	R8	R9	R10	R11	R12	R13	R14	R15
84,63	92,94	95,48	82,82	84,30	88,18	85,70	67,65	18,04	81,95	81,96	63,82	87,33	98,29	79,31

TM30 C values, 16 binned values out of total of 99 C values

C1	C2	C3	C4	C5	C6	C7	C8	C9	C10	C11	C12	C13	C14	C15	C16
76,18	84,06	78,50	87,14	89,47	93,76	88,96	87,02	81,60	72,74	75,01	84,85	84,24	86,27	75,75	75,39

CQS Q values

Q1	Q2	Q3	Q4	Q5	Q6	Q7	Q8	Q9	Q10	Q11	Q12	Q13	Q14	Q15
82,31	98,06	79,38	74,02	79,45	82,66	86,25	89,21	97,92	89,55	84,73	82,73	82,49	73,90	77,14

CQS: 82,5

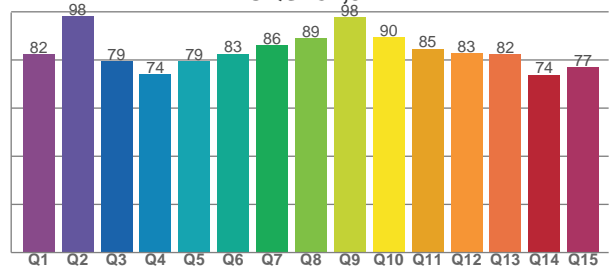

Color parameters

CCT	CRI	CRI R9	TM30 Rf	TM30 Rg	CQS	x	y	u	v	Duv
4058 K	85,2	18,0	82,4	94,8	82,5	0,4	0,4	0,2	0,3	0,0031

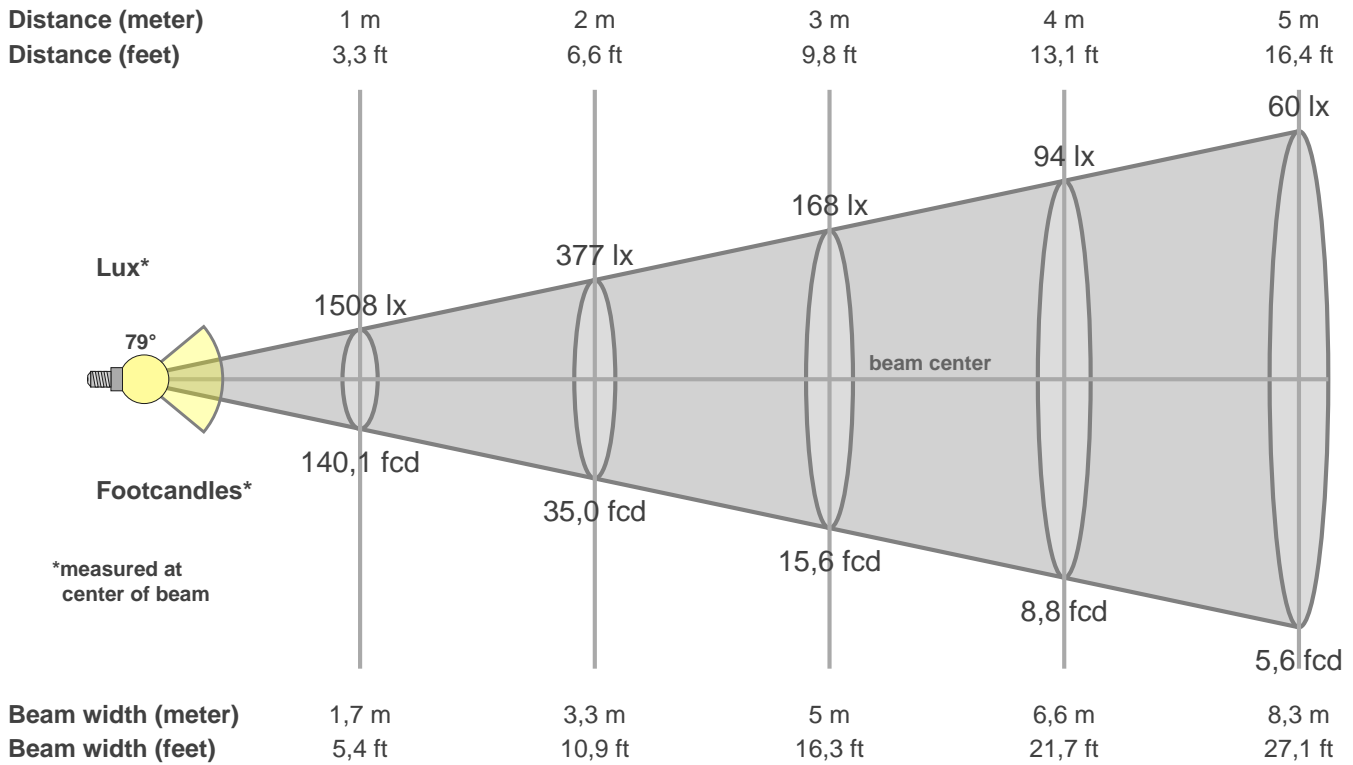

Intensities in 0° c-plane

0°	5°	10°	15°	20°	25°	30°	35°	40°	45°	50°	55°	60°	65°	70°	75°	80°	85°	90°	95°
1508	1504	1488	1456	1407	1343	1229	1048	800	570	396	286	225	208	182	149	113	65	23	13
100%	100%	99%	97%	93%	89%	82%	70%	53%	38%	26%	19%	15%	14%	12%	10%	7%	4%	2%	1%

Intensities in 90° c-plane

0°	5°	10°	15°	20°	25°	30°	35°	40°	45°	50°	55°	60°	65°	70°	75°	80°	85°	90°	95°
1508	1501	1482	1451	1400	1334	1231	1061	797	547	386	278	220	203	185	139	100	61	22	13
100%	100%	98%	96%	93%	88%	82%	70%	53%	36%	26%	18%	15%	13%	12%	9%	7%	4%	1%	1%

Intensities in 180° c-plane

0°	5°	10°	15°	20°	25°	30°	35°	40°	45°	50°	55°	60°	65°	70°	75°	80°	85°	90°	95°
1508	1493	1471	1429	1374	1295	1159	900	623	452	325	242	211	191	152	119	84	34	14	13
100%	99%	98%	95%	91%	86%	77%	60%	41%	30%	22%	16%	14%	13%	10%	8%	6%	2%	1%	1%

Intensities in 270° c-plane

0°	5°	10°	15°	20°	25°	30°	35°	40°	45°	50°	55°	60°	65°	70°	75°	80°	85°	90°	95°
1508	1498	1476	1435	1386	1302	1161	898	629	460	337	254	220	201	160	125	89	40	13	14
100%	99%	98%	95%	92%	86%	77%	60%	42%	31%	22%	17%	15%	13%	11%	8%	6%	3%	1%	1%

Beam angle 50%	Field angle 10%	Cutoff angle 2,5%	Intensity ratio in 120° cone	Intensity ratio in 90° cone
79,2°	150,8°	360,0°	80,1%	65,1%